



GLOBAL
FIRE EQUIPMENT



JUNIOR V4

Fire Alarm Control Panel

INSTALLATION

&

COMMISSIONING MANUAL

CONTENTS

OVERVIEW

Introduction.....	5
Key Features.....	5
Access Levels.....	6
Typical System Schematic.....	7
Power Requirements.....	8
Battery Requirements.....	9
ABS box information.....	10
Identifying Components.....	11
EN54 Information.....	14
Recommended Cables.....	15
Analogue Loops, Conventional Sounders and Data Loops.....	15
Limitations.....	15
Definitions.....	16

INSTALLATION

Introduction.....	17
Panel.....	17
Mains Power Connection.....	17
Other Panel connections.....	17
Repeaters.....	17
Panel Main Board - Connection Definitions.....	18
Fitting Junior Expansion Loop Card.....	19
Data Loops.....	20
Panel RS485.....	21
Repeater RS485.....	22
Panel Fibre Optic.....	23
Repeater Fibre Optic.....	24
Analogue Loop.....	25
Conventional Sounders.....	26
Auxiliary Fire Relays (2) and Fault Relay (1).....	26
Panel Batteries.....	27

COMMISSIONING

Introduction.....	28
The Panel Buttons.....	28
Getting The Panel Running.....	31
Getting A Repeater Running.....	31
Getting Into Programming Mode.....	32
Getting The System Running.....	34
Communications Check.....	34
Panel Check.....	34
Learning Which Devices Are Fitted.....	35
Sounder Audibility Check.....	35
Panel.....	35

CONTENTS

COMMISSIONING (cont...)

- Getting The System Running(cont...)36
 - Analogue Loop Monitoring36
 - Open Circuit Test36
 - Conventional Sounder Monitoring36
 - Detector Tests37
 - Detector Tests By Zone37
 - Unassigned Detector Test37
- Wrapping Up Installation And Commissioning37
 - Battery Fault Message Test38
 - Power Failure Test38

ADVANCED FUNCTIONALITY

- Programming Functions General39
 - Complete List Of Functions39
 - Keys To Use Within Functions40
 - General40

Specific Functions

- 1 Review Historic Log41
 - 1-1 Display Historic Log41
 - 1-3 Clear Historic Log41
 - 1-5 Read/Clear Autostart Count41
- 3 Zones - Disable & Assign42
 - 3-1 Disable Zones42
 - 3-2 Assign Sounder Groups to Zones42
 - 3-3 Assign I/O Groups to Zones42
 - 3-4 Assign Zone to Device42
 - 3-5 Zone Sounder Delay Set-up42
- 4 Sounders - Disable & Assign43
 - 4-1 Sounder Configuration43
 - 4-2 Configure Sounder Groups43
 - 4-3 Disable Sounders44
 - 4-4 Assign Sounder Group to Device44
 - 4-5 Inhibit Sounders for Device44
 - 4-6 Sounder Delay Set-up45
 - 4-7 Override Sounder Delays45

CONTENTS

5 Input/Output - Disable & Assign.....	46
5-1 Configure I/O Groups.....	46
5-2 Select Fault I/O Group.....	46
5-3 Assign I/O Group to Device.....	47
5-4 Inhibit I/O for Device.....	47
5-5 I/O Unit Action upon Evacuate.....	47
5-6 I/O Unit Delay or Immediate.....	47
5-7 I/O Delay Set-up.....	47
6 Device Set-up.....	48
6-1 General.....	48
6-1-1 Disable Loops	48
6-1-2 Device Disable.....	48
6-1-3 Set Selective Disablement.....	48
6-1-4 Set Device Reporting Details.....	49
6-1-5 Set Immediate Evacuate for Device.....	49
6-1-6 Device Activation Overrides Delays.....	49
6-1-7 Inhibit Auxiliary Relays.....	49
6-1-8 Global Sensitivity Set-up.....	50
6-1-9 Configure Timed Sensitivity.....	50
6-2 Other Device options.....	51
6-2-1 Select Device Heat Grade.....	51
6-2-2 Select Device Smoke Sensitivity.....	51
6-3 Discovery Specific.....	52
6-4 Automatic Address Setting (SAM).....	54
6-4-1 Activate ASET Mode (SAM).....	55
6-4-2 Clear Loop.....	56
6-4-3 Clear Device.....	56
Troubleshooting SAM.....	57

CONTENTS

7 Monitor Device Counts & Test	58
7-1 Device Count, Type & Value.....	58
7-2 Test Sounders.....	58
7-3 Sounders on Test Activation.....	58
7-4 Test Zones.....	58
7-6 Light LED on device.....	58
8 General	59
8-1 Time/Date & Timers.....	59
8-1-1 Set Date & Time.....	59
8-1-2 Define Day & Night.....	59
8-1-3 Delays Off at Night.....	59
8-1-4 Configure Evacuate Timer.....	60
8-1-5 Device Starts Evacuate Timer.....	60
8-2 Special Features Set-up.....	61
8-2-1 Two Devices to Evacuate.....	61
8-2-2 Call Points to Evacuate.....	61
8-3 Memory - BEWARE, ENGINEERS ONLY.....	61
8-3-1 Clear Customer Flash Memory.....	61
8-3-2 Clear Non-Volatile RAM.....	62
8-3-3 Calculate Customer Flash Checksum.....	62
8-3-4 Calculate Program Flash Checksum.....	62
8-4 Other Features.....	63
8-4-1 Active/Installation Mode.....	63
8-4-2 Upload/Download Link to PC.....	63
Uploading/Downloading Customer Site Data.....	63
The PC Loader Software.....	64
Windows® COM PORT Set-up.....	64
The Panel.....	64
8-4-4 Set User Access Code.....	65
8-4-5 Set User Access Facilities.....	65
8-4-6 Select language.....	65
8-4-8 Set Installer Code.....	65
TECHNICAL SPECIFICATIONS	66
CE DECLARATION OF CONFORMITY	68

OVERVIEW

Introduction

This document covers the installation and commissioning of a JUNiOr fire alarm panel. This document is intended for use by a competent, qualified, fire alarm installation engineer.

The JUNiOr fire alarm system should be tailored to the building requirements. The complete system should be designed to meet all applicable regulations. The installation must then be performed in accordance with the system design. This manual not only clarifies the components and connections during installation but will also assist in commissioning and maintenance.

This manual covers the installation and commissioning of a complete system.



ELECTRO-STATIC SENSITIVE DEVICES (ESD)
TAKE SUITABLE ESD PRECAUTIONS WHEN REMOVING OR
INSTALLING PRINTED CIRCUIT BOARDS.

All PCBs contain Electrostatic Sensitive Devices.

Take suitable ESD (Electrostatic Discharge) precautions when removing or installing printed circuit boards (PCBs).

This manual has been written for panel software revision 3.07. Newer versions of panel software will be similar but some details may differ.

JUNiOr FIRE ALARM PANEL Key Features

- Single loop panel - Expandable up to 2 loops.
- Supports connection to Mini-repeater via RS485, Fibre-Optic or TCP/IP
- 125 device addresses per loop
- Up to 96 VULCAN (addressable) ultra low current base sounders (32 address limit)
- 32 individually programmable sounder addresses
- Full SAM & MAM support - Wismart & GFE protocol only
- 2 Fire output relays (change-over) and 1 Fault relay (nc - opens on fault)
- 2 conventional alarm outputs (Individually programmable)
- Both detection loops monitored for integrity
- 384 fully programmable zones
- 512 fully programmable sounder groups
- 512 I/O groups
- Event log (rolling, 2000 entries)
- Available in Apollo, GFE or Wismart Protocol versions (Hochiki pending)
- Compatible with all our own low cost ancillary modules
- Backlit LCD display with 4 rows of 40 characters
- Programming by integrated keypad or Loader PC software (Juno Net Loader Version 2.12)
- Multiple language support (menu selectable)
- Integrated 16 zone LED fire zone indication

OVERVIEWACCESS LEVEL 1 - General User

Unless otherwise indicated, in order to enable the operation of a particular switch, either a valid User or Programming Access Code is required to be entered.

The only exceptions are the following:

- 1- Lamp Test Switch
- 2- Queue Review Switches(Fire, fault, Test and Disabled)
- 3- Delays Active Switch. During an alarm condition and while delays are active.

By entering a valid User Access Code (Factory default 12345678), the authorized user gains access to the operation of all switches at the front of the panel's display. Authorized User Access also grants the possibility of enabling or disabling zones.

ACCESS LEVEL 2 -Authorized User Controls

Access to this level is accomplished by the introduction of a code using the panel's keypad. The user code is factory set to 123456 and after entering each digit in turn, press OK to confirm entry.

INTERNAL BUZZER SILENCE

The occurrence of any new fire or fault condition will initiate the operation of the internal buzzer. By pressing this switch, the operation of the buzzer will be stopped until a new fire or fault appears on the system.

ALARM SILENCE / RESOUND

Activates all sounders. A second press deactivates all sounders. The button LED (red) is illuminated whilst the sounders are activated.

SOUNDERS ENABLE /DISABLE

Pressing this button will enable/disable all sounders both conventional sounder circuits and addressable sounders.

DELAYS ACTIVE

Pressing this button will activate any preprogrammed delays. The yellow LED associated with this button and the general disablements LED will both be lit. A second press of this button will deactivate the delays and the LED. Under any fire condition the delays will be activated. If during the course of these delays, at access level 1 (General User - code entry not required), this button is pressed, the delays will be overridden and the sounders and together with any other fire indicating equipment, will be activated.

USER & INSTALLER ACCESS CODES

To enter both codes use the arrow keys \leftarrow \rightarrow and when finished press ENTER.

Access Level 2 - Press ENTER, then Authorized User Access Code 123456 and then press ENTER to confirm entry.

Access Level 3 - Press ENTER, then Installer Access Code 123456 and then press ENTER to confirm entry

FRONT PANEL KEYPAD KEY'S INSTRUCTIONS

- ENTER Used to confirm entry of any data or selection.
 \rightarrow Used to increase selection or number. Also used for code entry.
 \leftarrow Used to decrease selection or number. Also used for code entry.
 \leftrightarrow Used to change, when required, from Loop 1 to 2 and vice versa.
ESC Escape key. Used to exit a particular function.

NOTE:

It is not possible to introduce text for labels using the front panel keypad.

OVERVIEW

Typical System Schematic

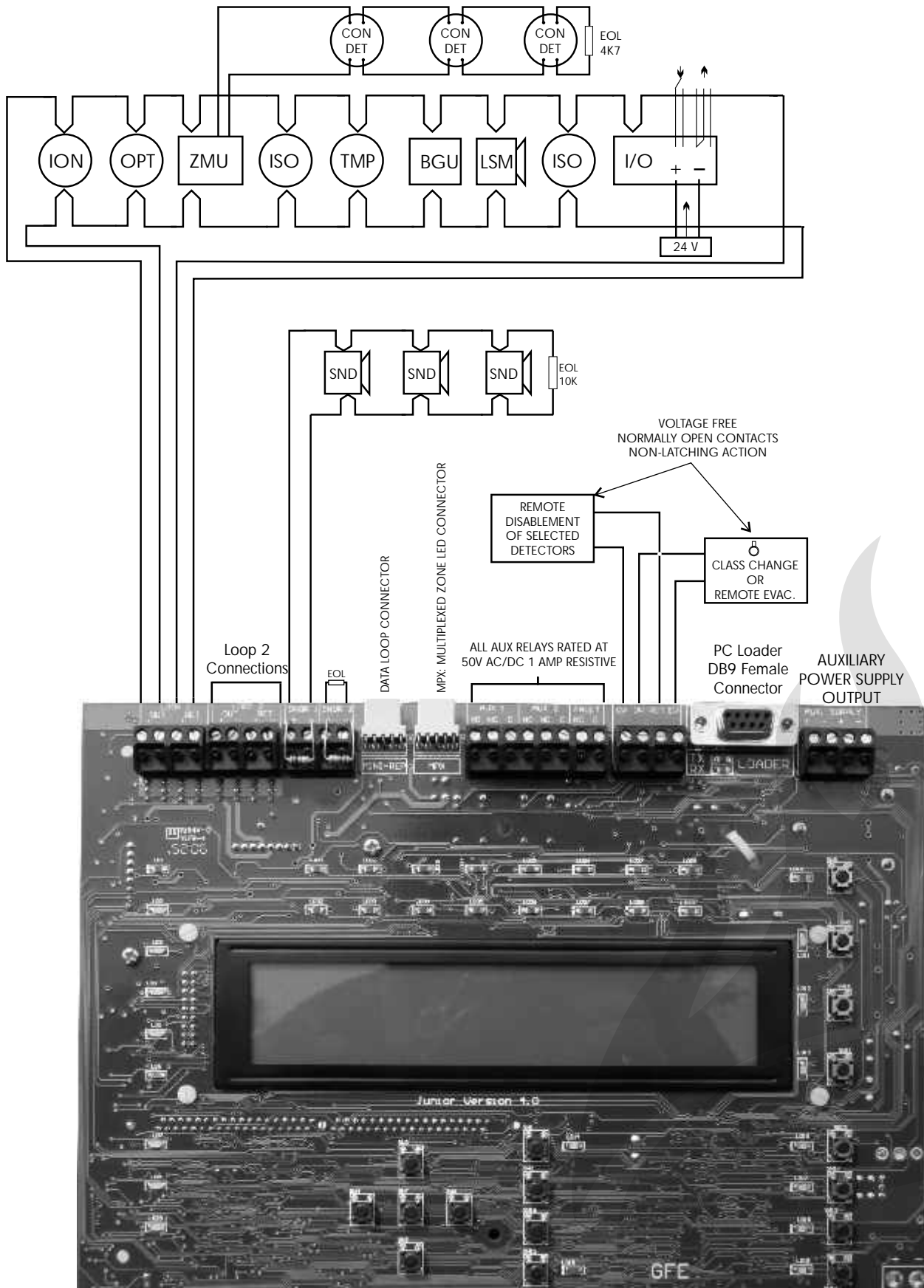

OVERVIEW

Power Requirements

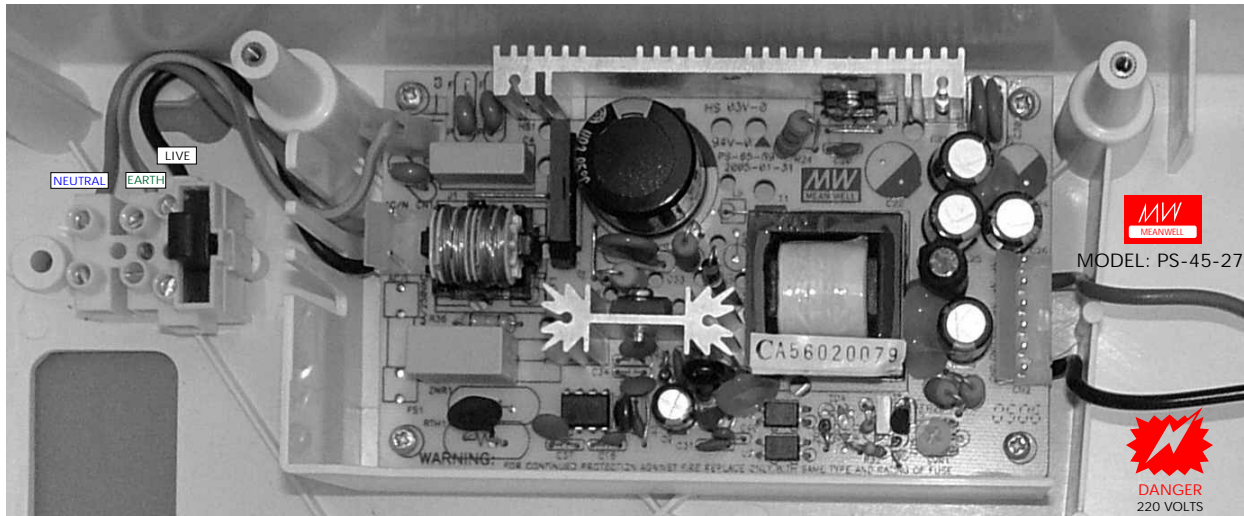

Power Supply Specification - MEANWELL Model: PS-45-27	
Mains supply voltage	85-264V 50/60 Hz
Internal power supply	Min. 20 V DC – Max. 30 V DC (28.5 V DC nominal) Max. Ripple 1 V peak-peak
Total output current	1,7A @230Vac
Supply and battery charger monitored	YES
Batteries monitored	YES
Max Battery size	2 x 12V 7AH VRLA
Mains Fuse	4 A – 250 V Slow Blow – 20 mm
Battery Fuse	1.6 Amp Resettable – Electronic Fuse
Max Current Draw from Battery (Mains Fail)	1.5 Amp Max. @ Max. Operating Temperature

Voltage

Primary supply voltage 85 - 264 V A.C.
 EMC Standard EN55022 class B
 EN61000-4-2,3,4,5,6,8,11
 EN61000-3-2,3

Current 1.7A PSU's recommended for 1 and 2 loop panels.

The maximum alarm sounder current is 400mA for both conventional sounder circuits.
 The maximum quiescent current per loop is 275mA. The loop short circuit (trip) current is 900mA.

Battery

Internal maximum 24V / 7AH

OVERVIEW

Battery Requirements

The battery AH required are calculated from the following formula

$$\left(\begin{array}{l} \text{Quiescent current in mA of} \\ \text{the panel with everything} \\ \text{connected.} \end{array} \times \begin{array}{l} \text{Standby time required in} \\ \text{hours divided by 1000.} \end{array} \right) + \left(\begin{array}{l} \text{Alarm current in Amps} \\ \text{(sounder load)} \end{array} \times \begin{array}{l} \text{Alarm time in hours} \end{array} \right) + 20\%$$

Round up to the next available battery size.

Quiescent currents for individual equipments are listed below:

EQUIPMENT	QUIESCENT CURRENT (mA)	ALARM CURRENT (mA)
Junior Panel	80	105
24V auxiliary outputs (2 off)	Refer to connected devices	

NOTE:

For 2 loop panels 7AH batteries are always recommended.

Example

A given installation has a single loop panel with 58mA detector load, 1.4A sounder load (including loop sounders) and a 24 hour standby requirement.

$$\left(\begin{array}{l} \text{Quiescent current in} \\ \text{mA of the panel with} \\ \text{everything connected.} \end{array} \times \begin{array}{l} \text{Standby time} \\ \text{required in hours} \\ \text{divided by 1000.} \end{array} \right) + \left(\begin{array}{l} \text{Alarm current in Amps} \\ \text{(sounder load)} \end{array} \times \begin{array}{l} \text{Alarm time in} \\ \text{hours} \end{array} \right) + 20\%$$

$$\begin{array}{l} \begin{array}{l} 80 \text{ (Jr. panel)} \\ + \\ 58 \text{ (detector load)} \end{array} \quad \begin{array}{l} 24 \text{ (standby in hrs)} \\ \text{divided by} \\ 1000 \end{array} \quad \begin{array}{l} 105 \text{ (Jr. panel)} \\ + \\ 58 \text{ (detector load)} \end{array} \quad \begin{array}{l} 0.5 \\ \text{(alarm time in hrs)} \end{array} \\ \downarrow \quad \downarrow \quad \downarrow \quad \downarrow \\ \left(\begin{array}{l} 138\text{mA} \\ \times \\ 0.024\text{H} \end{array} \right) + \left(\begin{array}{l} 1.563\text{A} \\ \times \\ 0.5\text{H} \end{array} \right) \\ \underbrace{\hspace{10em}} \quad \underbrace{\hspace{10em}} \\ 3.312\text{AH} \quad \quad \quad 0.782\text{AH} \\ + \\ = 4.094 \text{ AH} + 20\% (0.82\text{AH}) = 4.913 \text{ AH} \\ \text{The next available battery size is 5 AH} \end{array}$$

OVERVIEW

ABS box information

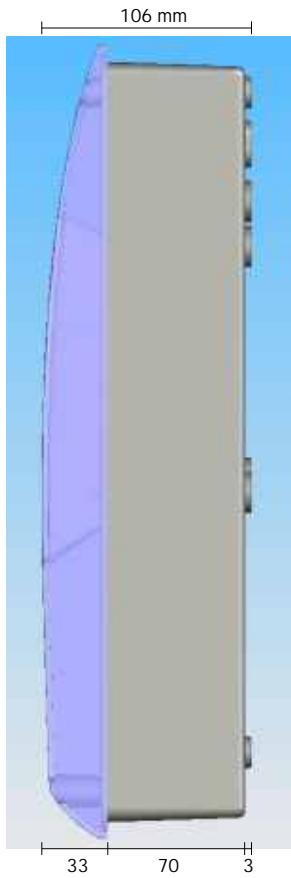

VIEW FROM SIDE

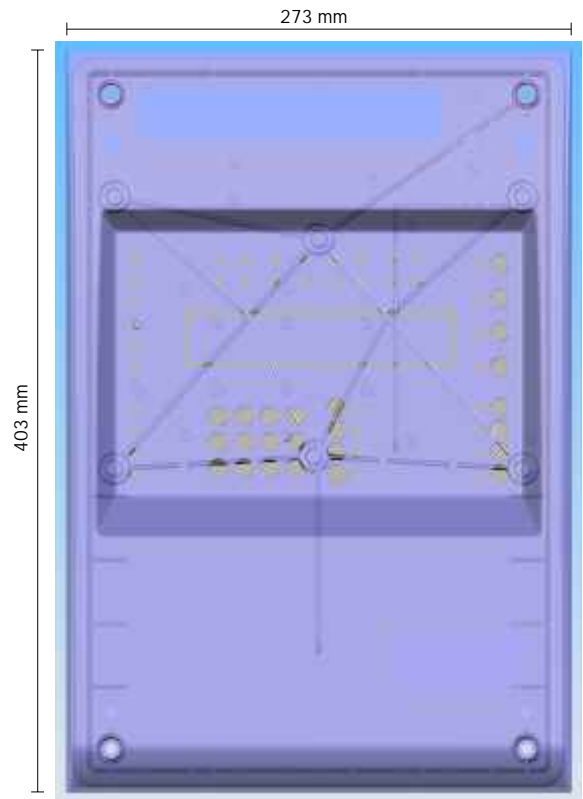

VIEW FROM FRONT

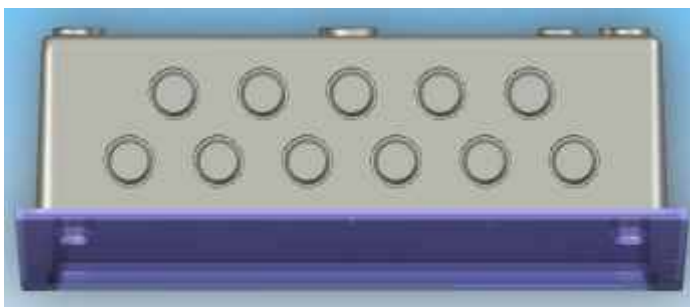

VIEW FROM TOP

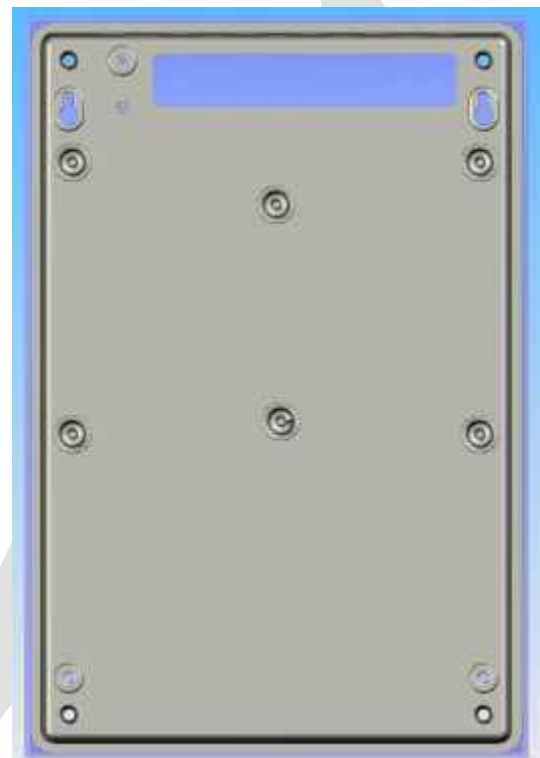

VIEW FROM REAR

Dimensions	
Size	273 (W) x 403 (L) x 106 (H) mm
Weight without batteries	1,6 Kgs

OVERVIEW

Identifying Components

Inside JUNiOr

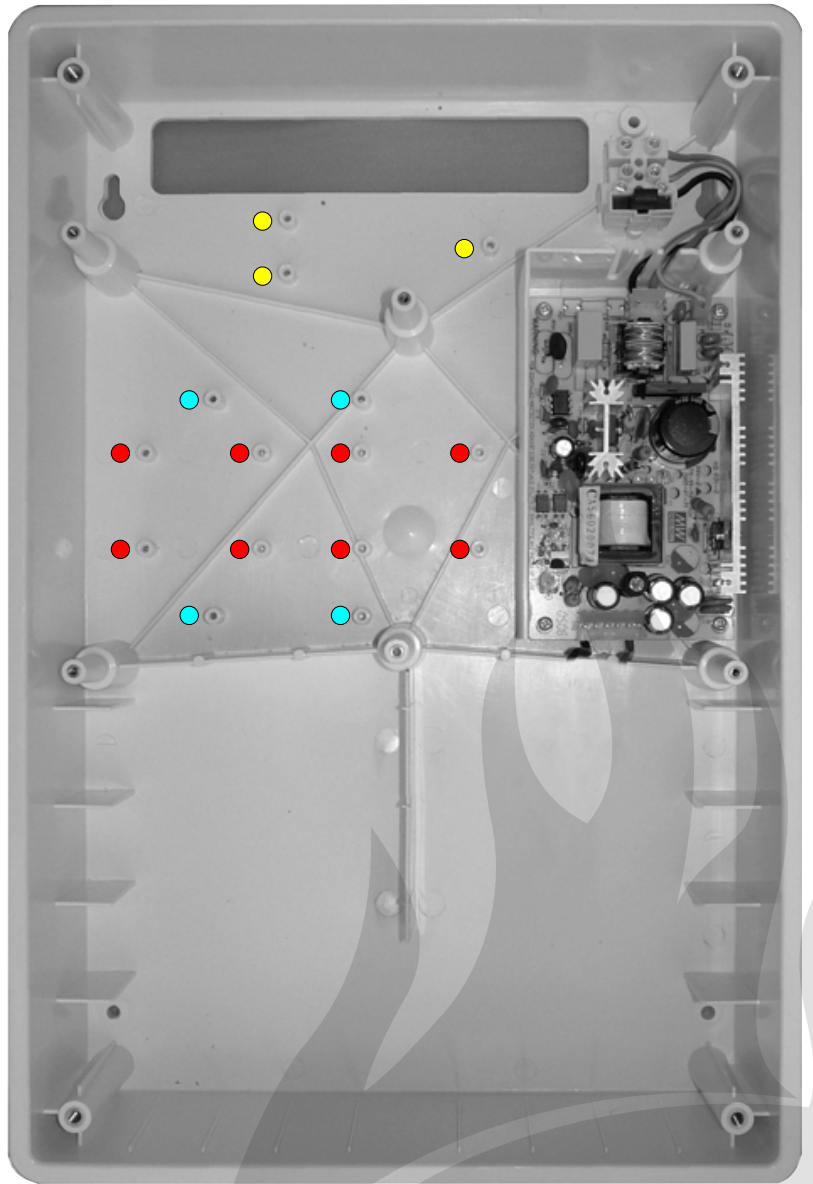
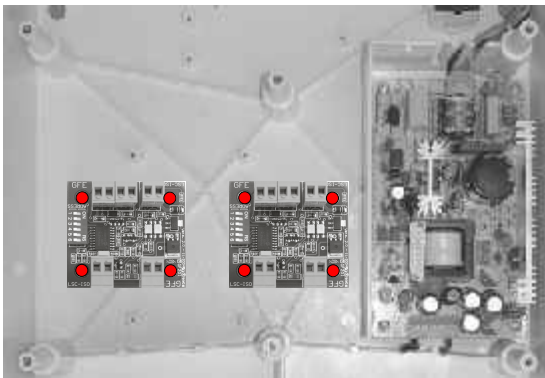
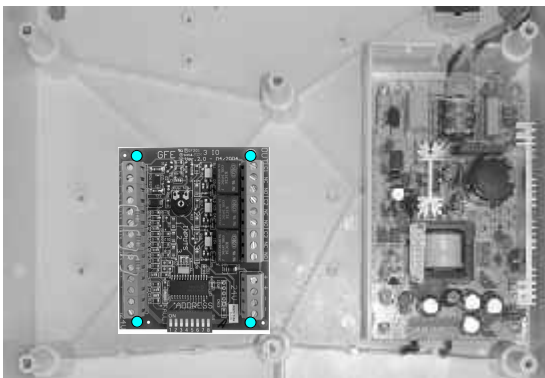
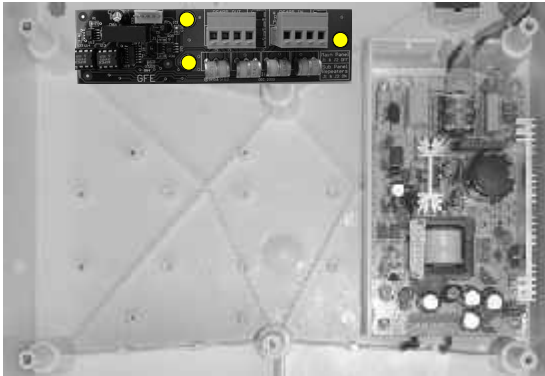

OVERVIEW

Identifying Components

JUNIOR-MB: JUNIOR MAIN BOARD FRONT VIEW

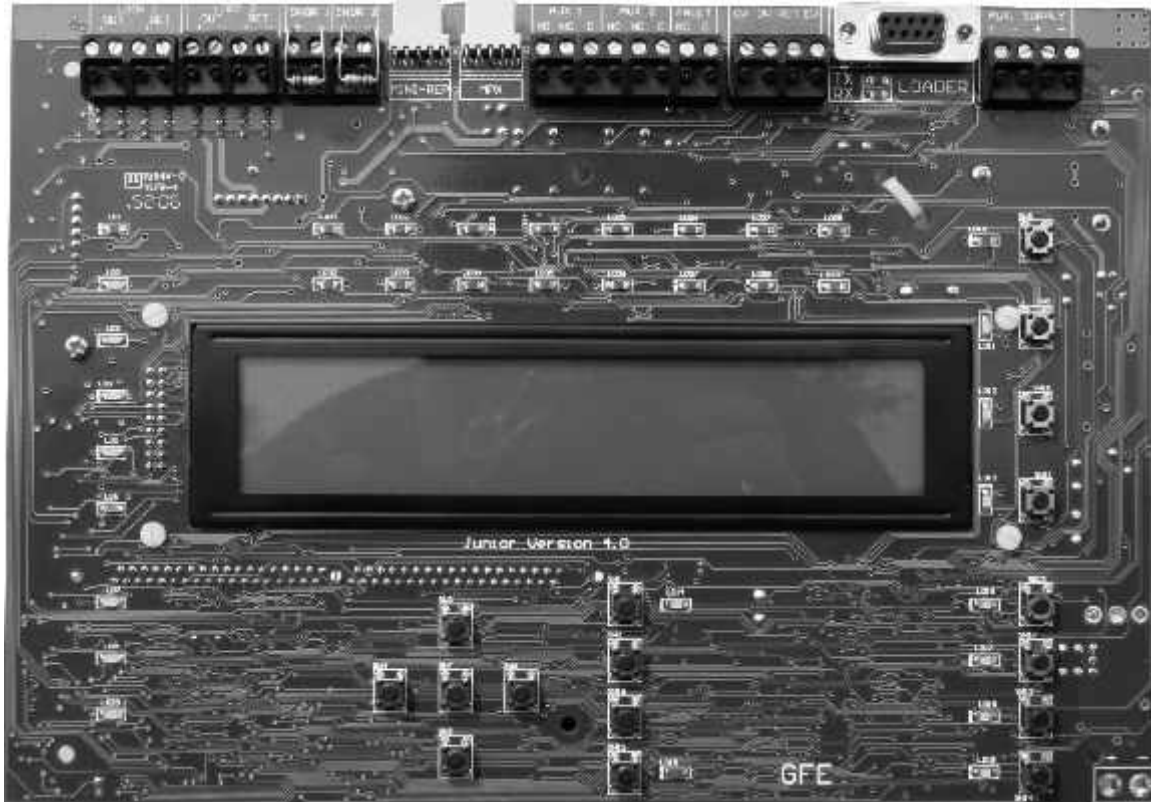

REAR VIEW

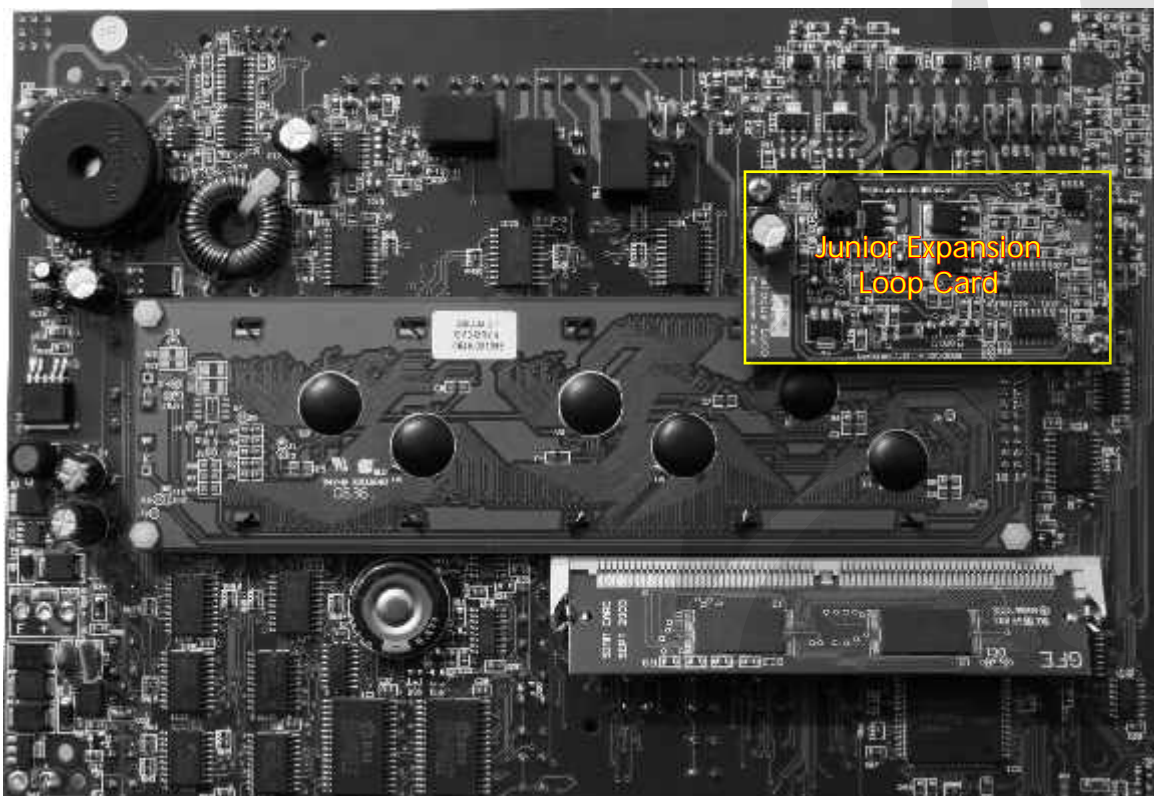

OVERVIEW

Identifying Components

NOTE: Junior can only be networked with repeater panels.

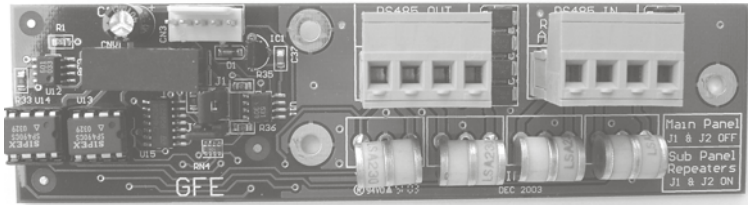

J-NET-INT-485-NEW
INTERFACE FOR RS485
COMMUNICATION

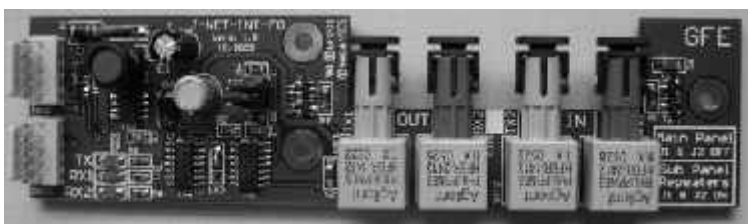

J-NET-INT-FO:
FIBRE OPTIC INTERFACE

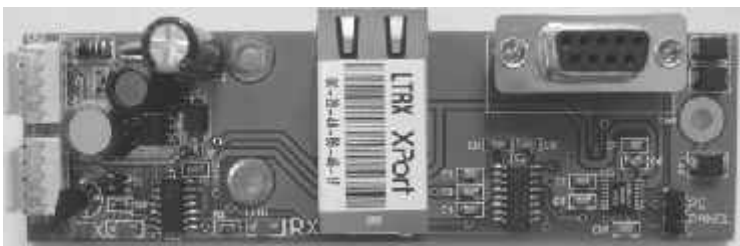

J-NET-INT-TCP/IP
INTERFACE FOR TCP/IP
COMMUNICATION

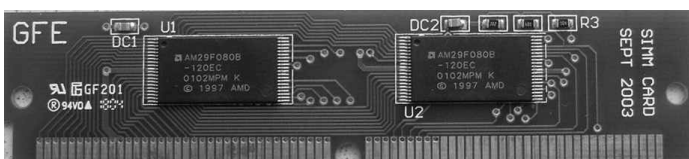

JUNIOR-SIM:
JUNIOR SIM CARD

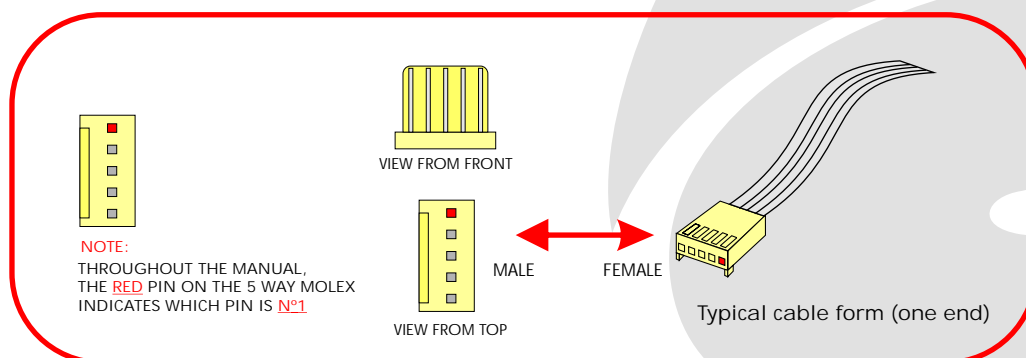

OVERVIEW

EN54 INFORMATION

In accordance with EN54pt.2 1997/AC:1999 clause 13.7, the maximum number of sensors and/or manual call points in this panel, will not exceed 512 units.

The Fire Detection Control Panel complies with the requirements of EN54 pt. 2 and 4 1997/AC:1999. In addition to the requirements of the above mentioned standard, the unit conforms to the following optional functions:

<u>OPTION</u>		<u>EN54 pt. 2 Clause</u>
<u>Indication</u>	Fault Signals from Points	8.3
<u>Controls</u>	Delays for activation of outputs	7.11
	Disablement of each Addressable point	9.5
	Test Condition	10
<u>Outputs</u>	Outputs to fire alarm devices	7.8

In addition to the functions required by the standard EN54 pt. 2 1997/AC:1999, the panel supports ancillary functions that are not required by the above mentioned standard, namely:

Ancillary Functions:

Panel network connection ports

Panel to PC programming software (upload / download) port.

Remote class change

Auxiliary relays outputs

Analogue Loops:

Each analogue loop can be connected to a maximum of 125 devices. According to EN54 pt. 2 clause 12.5.2, in case of a short circuit or interruption of the analogue detection loop only a maximum of 32 detectors or call points per loop, can be prevented at any one time, of transmitting a fire alarm. In order to assure compliance with this clause, a loop isolator must be installed after every 32 detection devices.

OVERVIEW

Recommended Cables

Analogue Loops, Conventional Sounders and Data Loops

Fire rated Cables for Loops and Sounder Circuits

AEI type Firetec Multicore Ref. F1C1 (1 mm²) to F1C2.5 (2.5 mm²) in 2 core
AEI type Firetec Armoured Ref. F2C1 (1.5 mm²) to F2C2.5 (2.5 mm²) in 2 core
AEI type Mineral Insulated Cable (all types up to 2.5 mm²)
BICC types Mineral Insulated twin twisted conductor cables, Ref. CCM2T1RG and CCM2T1.5 RG
BICC types Mineral Insulated Pyrotenax (all types up to 2.5 mm²)
CALFLEX type Calflam CWZ 2 core type up to 2.5 mm²
PIRELLI type FP200 Gold 2 core type from 1 mm² to 2.5 mm²
FIRETUF (OHLS) FTZ up to 2.5 mm². Manufactured by Draka

All cables must be screened.

Minimum detection loop conductor section size is 0.5 sq.mm
Maximum detection loop conductor section size is 2.5 sq.mm

There should only be one analogue detector loop per shielded cable.
Analogue detector loops and conventional sounders should not run in the same shielded cable.

If the system requires one or more repeaters, it will be necessary to use a four core data cable to create a data loop between the panel and the repeater. Alternatively, it is possible to use multi-mode dual-core fibre-optic cable or a TCP/IP connection for the same purpose.

Data loop cable should be RS422/485 grade data cable, eg:

Signal cables for RS485 Communication Links (twisted pair) to Repeater panels

12 AWG Signal 88202 Belden 9583 WPW999
14 AWG Signal 88402 Belden 9581 WPW995
16 AWG Signal 88602 Belden 9575 WPW991
18 AWG Signal 88802 Belden 9574 WPW975
FIRETUF FDZ1000 by Draka 2 core
PIRELLI type FP200 Gold 2 core
PIRELLI type FP-PLUS

Fibre Optic: Multi.mode Dual Core sheathed fire proff with 62,5µ/125µ fibre terminated in ST connectors

Limitations

A fire alarm system can provide early warning of a developing fire but it does not assure protection against damage or loss resulting from a fire.

The fire alarm system should be designed and installed in accordance with all relevant regulations and codes of practice.

To ensure maximum protection the system should be regularly tested and inspected by qualified fire alarm installation personnel. Inspection and testing should be carried out in accordance with the appropriate local standards.

OVERVIEW

Definitions

Analogue Loop The physical link, usually fireproof 2 conductor shielded wiring cable, forming a ring of interconnection between sensors and the detection panel.

Cable form A connecting lead. Typically a length of flat cable with connectors at both ends.

Conventional Sounder A Conventional Sounder is an audible output device that is connected to the Conventional Sounder outputs on the Panel. It is different electrically to a Loop powered Sounder.

Data Loop This may take the form of RS485, a fibre optic link or by TCP/IP. It provides communications between the Panel and Repeaters.

Detector Any type of fire sensor (heat, smoke) that is connected to an Analogue Loop.

Device A detector, sounder, interface module or call-point connected to an Analogue Loop.

Evacuate A system state where all sounders are activated simultaneously. Pressing SOUND ALARMS will generate an evacuate condition.

Fibre Optic Link A connection method for data that uses light instead of electrical signals. The connection is made using fibre optic cables rather than copper electrical cables. Fibre optic signals can travel far greater distances than electrical signals with less risk of electromagnetic interference.

Flash Non-volatile memory inside the panel used to store the program and the customer site data. Flash data storage is very robust and needs no power at all to retain the data.

Local Sounder A local conventional sounder is an audible output device (bell or sounder) that is connected to the local bell output on the panel.

Loop Sounder The term Loop Sounder is used to describe an audible output device that is connected to and controlled individually by an Analogue Loop. Loop Sounders are different electrically from Conventional Sounders.

NVRAM Non-volatile Random Access Memory. Any information stored in this memory will not be cleared when power is removed from the system. The system has an internal battery for the NVRAM.

PCB Printed Circuit Board.

Repeater A Repeater is a remote terminal to the Panel. Everything that is displayed on the Panel, with the exception of zonal LEDs, is also displayed on the Repeater. Any LEDs illuminated on the Panel are illuminated on the Repeater. Key presses at the Repeater are sent directly to the Panel, as if the input were actually occurring at the Panel.

SIM CARD Single In-line Memory Card. Fitted to the SIM CARD is the Flash memory that contains the Panel software and the system settings (Customer Flash Memory).

The System The Panel, Repeaters and all devices.

Zone A situational group of devices. A Zone can consist of a collection of any of the devices connected to the system.

INSTALLATION

Introduction

This section covers the physical installation of the system. It primarily focuses on the parts that are required and how they should be connected together. Do not connect the mains power or the batteries at this stage; commissioning the system is covered in the next section of this manual.

Installation should always be performed in accordance with a system plan.

Panel

The control panel should be located where access to the internal components is not restricted and where the unit is not exposed to high levels of temperature, moisture, vibration and shock.

Any metal swarf could damage the PCBs if it is still present when the panel is powered up so it is recommended that all PCBs are removed from the box whilst the box is being installed. Make a note of the positions of the PCBs before removal.

Mains Power Connection

The panel must be earthed. The LIVE connection must be made to the fused input on the power supply module. This input will also have a BLACK or BROWN wire leading into the power supply unit.

The connector with a BLUE wire leading into the power supply unit is the NEUTRAL.

Other Panel connections

These are detailed in the relevant following sections. Most connections are made from the JUNiOr mainboard.

Repeaters

Repeaters are installed in a similar manner to the Panel. Each Jr. panel can supply a maximum of 4 Mini-repeaters.

The Repeater should be located where access to the internal components is not restricted and where the unit is not exposed to high levels of moisture, vibration and shock.

Avoid placing the Repeater in direct sunlight as this may impair reading of the LCD display.

Any metal swarf could damage the PCBs if it is still present when the Repeater is powered up so it is recommended that all PCBs are removed from the box whilst the box is being installed. Make a note of the positions of the PCBs before removal.



ELECTRO-STATIC SENSITIVE DEVICES (ESD)
TAKE SUITABLE ESD PRECAUTION WHEN REMOVING OR
INSTALLING PRINTED CIRCUIT BOARDS.

Warning - observe ESD precautions when handling the PCBs.

INSTALLATION

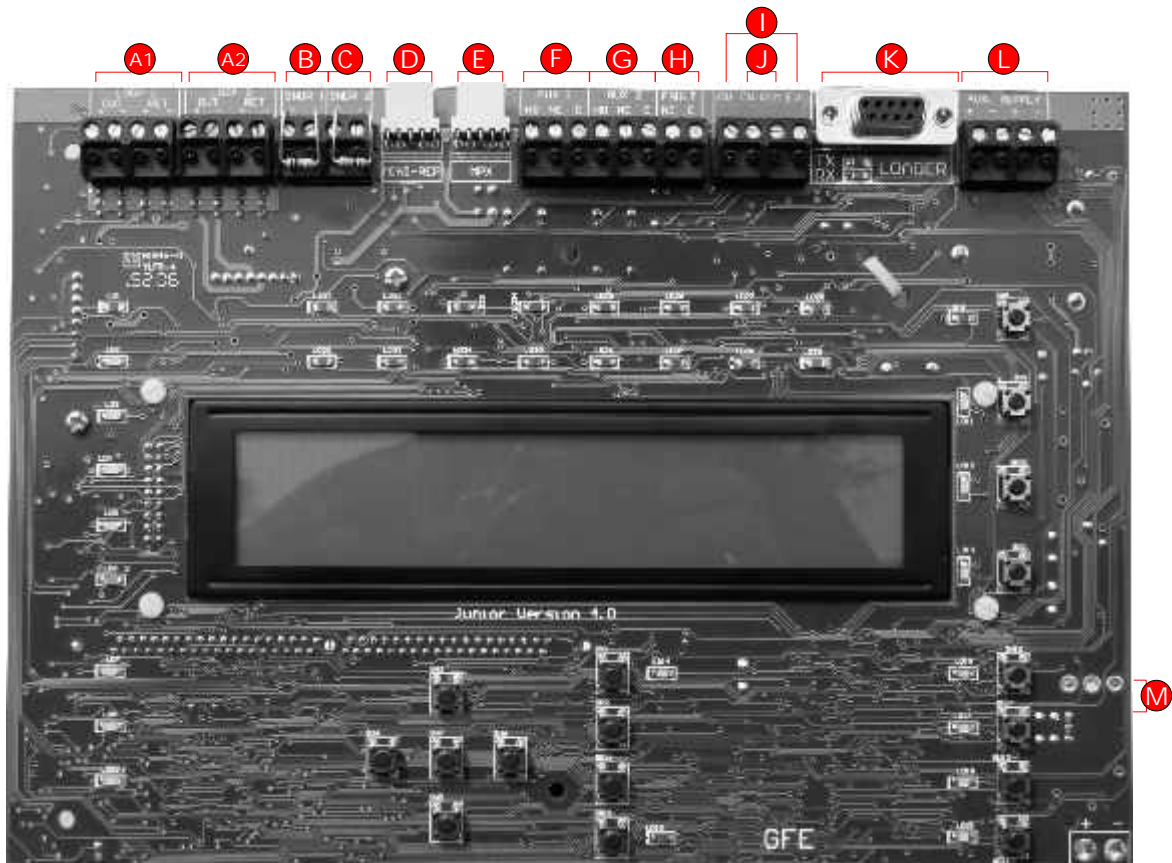

JUNIOR MAIN BOARD

- A** Loop connections. A1 corresponds to Loop 1 and A2 to Loop 2
- B** Conventional sounder circuit 1
- C** Conventional sounder circuit 2
- D** 5 pin connector for RS485, Fibre-optic or TCP/IP (LAN) connection with repeater panel
- E** 5 pin connector for multiplexed zone LEDs or relays
- F** Auxiliary change-over relay output 1 (Activated by any fire present on the system, disabled by front button)
- G** Auxiliary change-over relay output 2 (Activated by any fire present on the system, disabled by front button)
- H** Fault NC relay contact (Activated by any fault present on the system, opens on fault)
- I** Remote Evacuation or Class Change.
- J** Remote disablement of selected detectors
- K** 9 way D-type connector for upload/download interface (GFE Connector software required)
- L** 24V auxiliary power supply output for powering external devices.
Max 460mA power limited and monitored
- M** System power input
- N** 24V battery connection

INSTALLATION

Fitting Junior Expansion Loop Card

- 1.- This operation should only be performed by qualified personnel.
- 2.- Power to the panel should be completely removed, both primary and secondary (batteries) supplies, before the installation process of the card is initiated.
- 3.- After process is completed re-apply power to the panel.
- 4.- Panel should be in installation mode. Green (Status) LED should be flashing. See function 8.4.1
- 5.- Confirm using function 7.1 that devices attached to the 2nd loop are being detected by the panel.
- 6.- No programming is required in order to enable the expansion loop card. The 2nd loop is automatically detected by the panel.

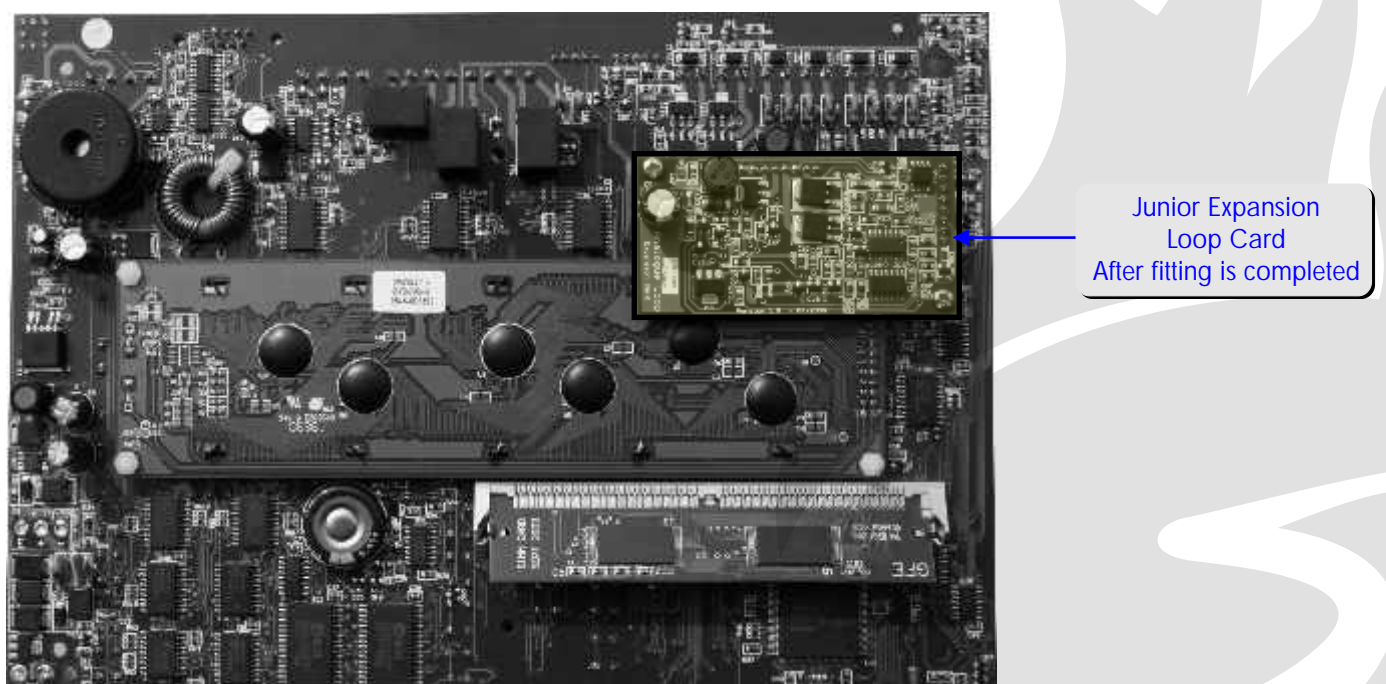
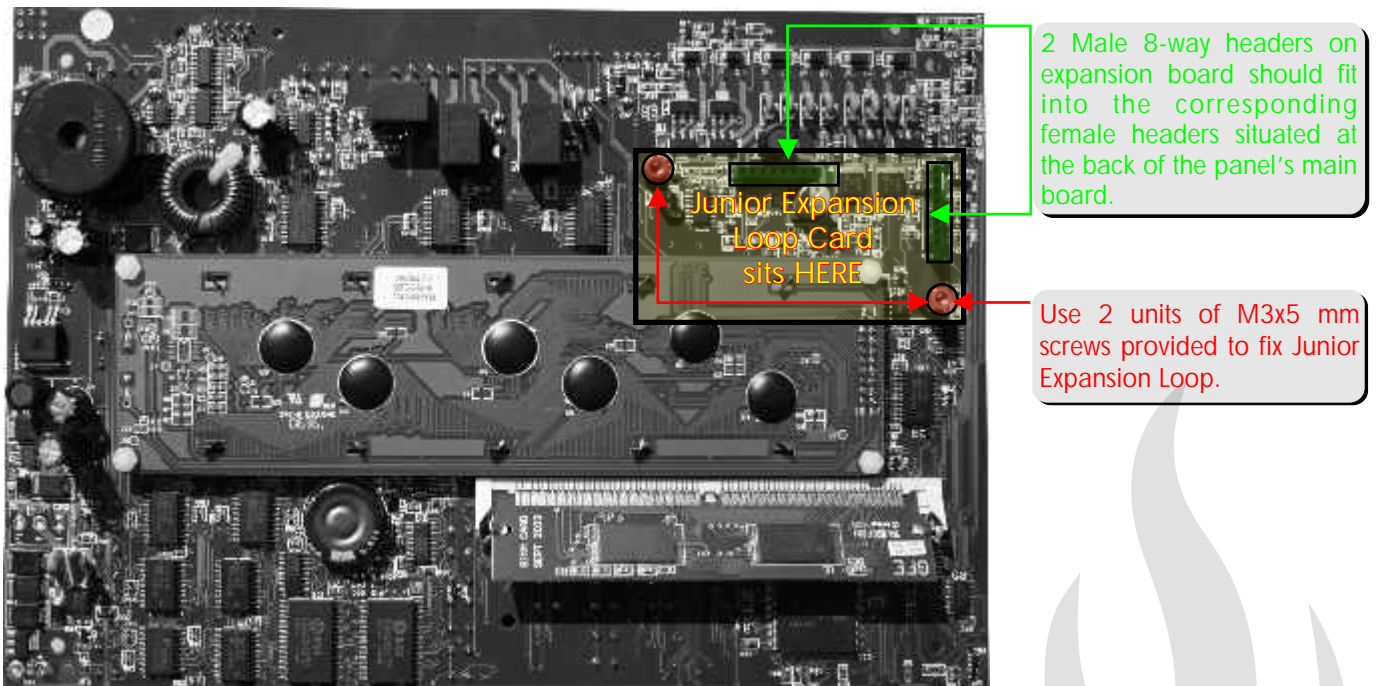

INSTALLATION

Data Loops

If the system includes mini-repeaters to allow remote viewing and control of the system, an RS422/485, Fibre Optic or TCP/IP connection may be used.

For redundancy in the case of RS422/485 and Fibre Optic this can be wired in the form of a Loop, thus protecting the Data Loop from interruptions or short circuits by creating a bi-directional communications flow. If the panel loses communications with the repeater it will try via the opposite path.

RS422/485 may be used for distances of up to 1200m. For longer distances (up to 4,5km) Fibre Optic Data connections should be used.

See page 15 for cable requirements for both types of installation.

JUNIOR TOPOLOGIES

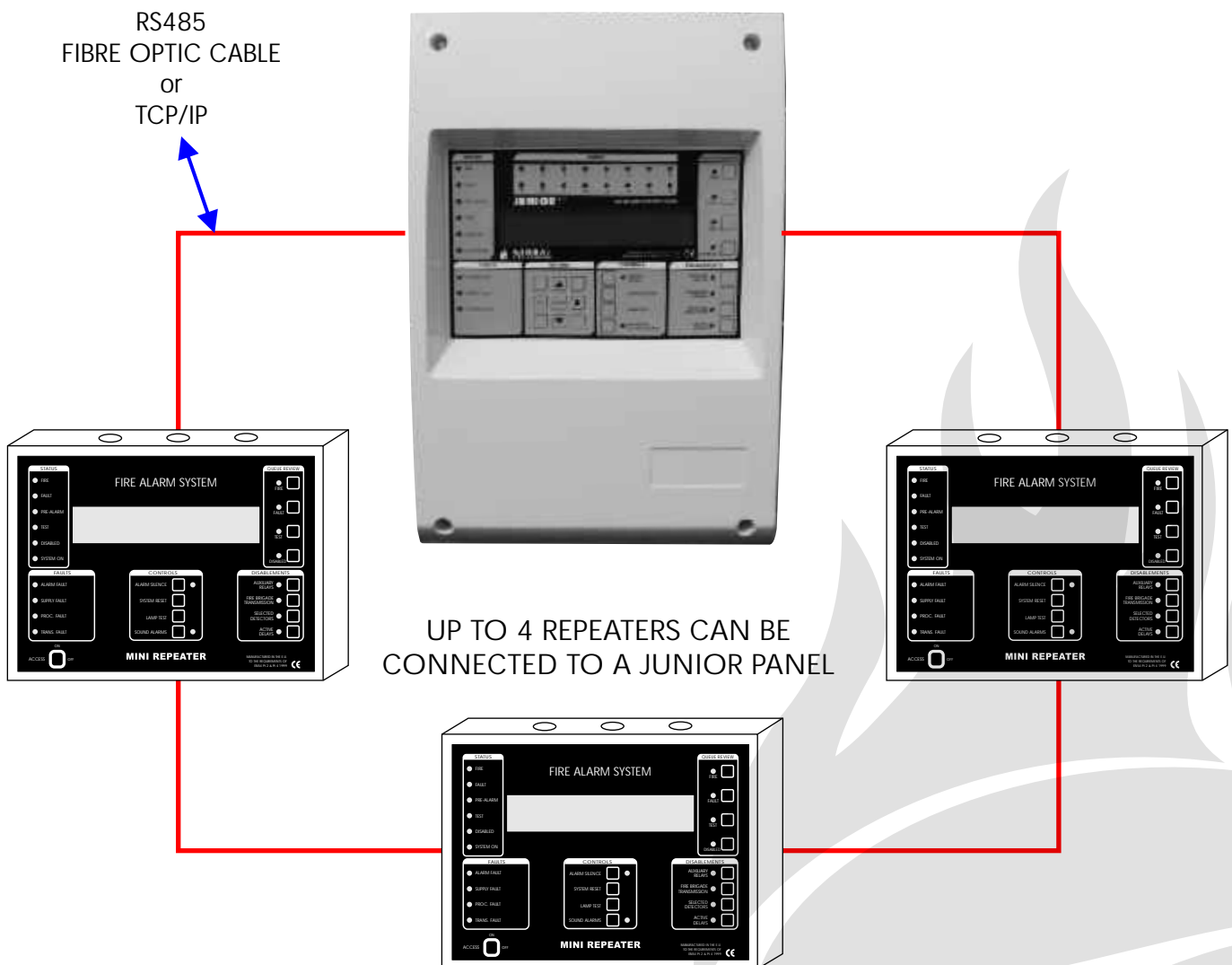

NOTE:

Only 2 Mini-Repeaters should be powered from the Auxilliary supply output of the Junior when the panel is equipped with 2 loops. Extra Mini-Repeaters should be powered by an external 24V DC power supply.

INSTALLATION

Panel RS485

NOTE:

Make all connections with the power turned off to avoid risk of permanent damage to the circuit boards.

If a repeater panel is required, the appropriate interface board for the desired communications media must be installed in both the panel and repeater.

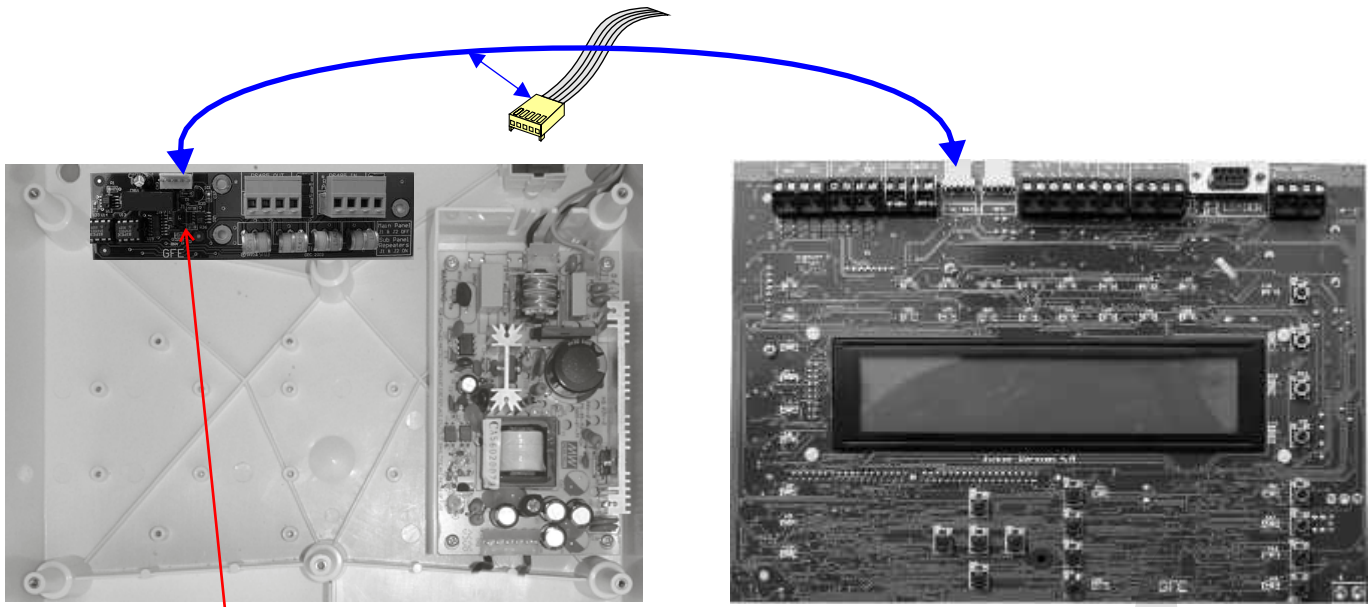

JUNIOR PANEL CONNECTIONS

LINKS J1 & J2

PANEL = **OFF** The interface inside the Junior panel must have the link jumpers OFF.
 REPEATER = **ON** The interface inside the Mini-Repeater must have the link jumpers ON.

RS485 External Connection

The 4 wire external RS485 connections should be made as follows:

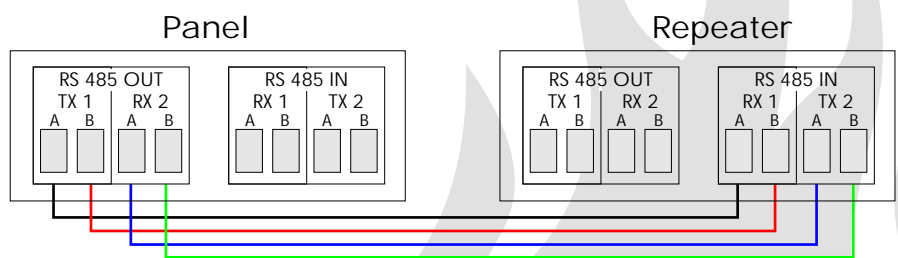
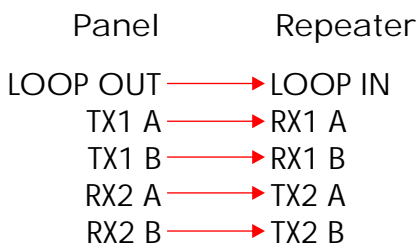

Then continue to connect OUT of one Repeater to IN of the next Repeater following the same connection rules as above. When you reach the last Repeater in the loop make the connections as follows:

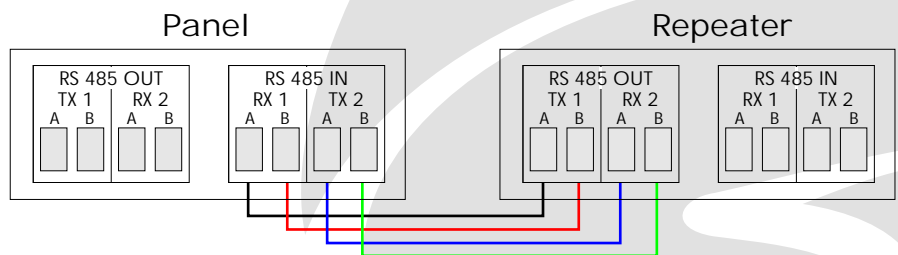
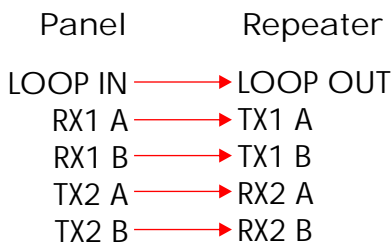

NOTE:

Connections shown are for a redundant Loop circuit. If Radial circuit must be used please contact technical support for information. techs@globalfire.pt

INSTALLATION

Repeater RS485

NOTE:

Make all connections with the power turned off to avoid risk of permanent damage to the circuit boards.

The repeater connections to the RS485 Interface are basically the same as for the Panel. The placement of the RS485 interface inside the Mini-repeater differs from the Junior's since it is placed vertically. The main board has a horizontal placement and does not require a loop card.

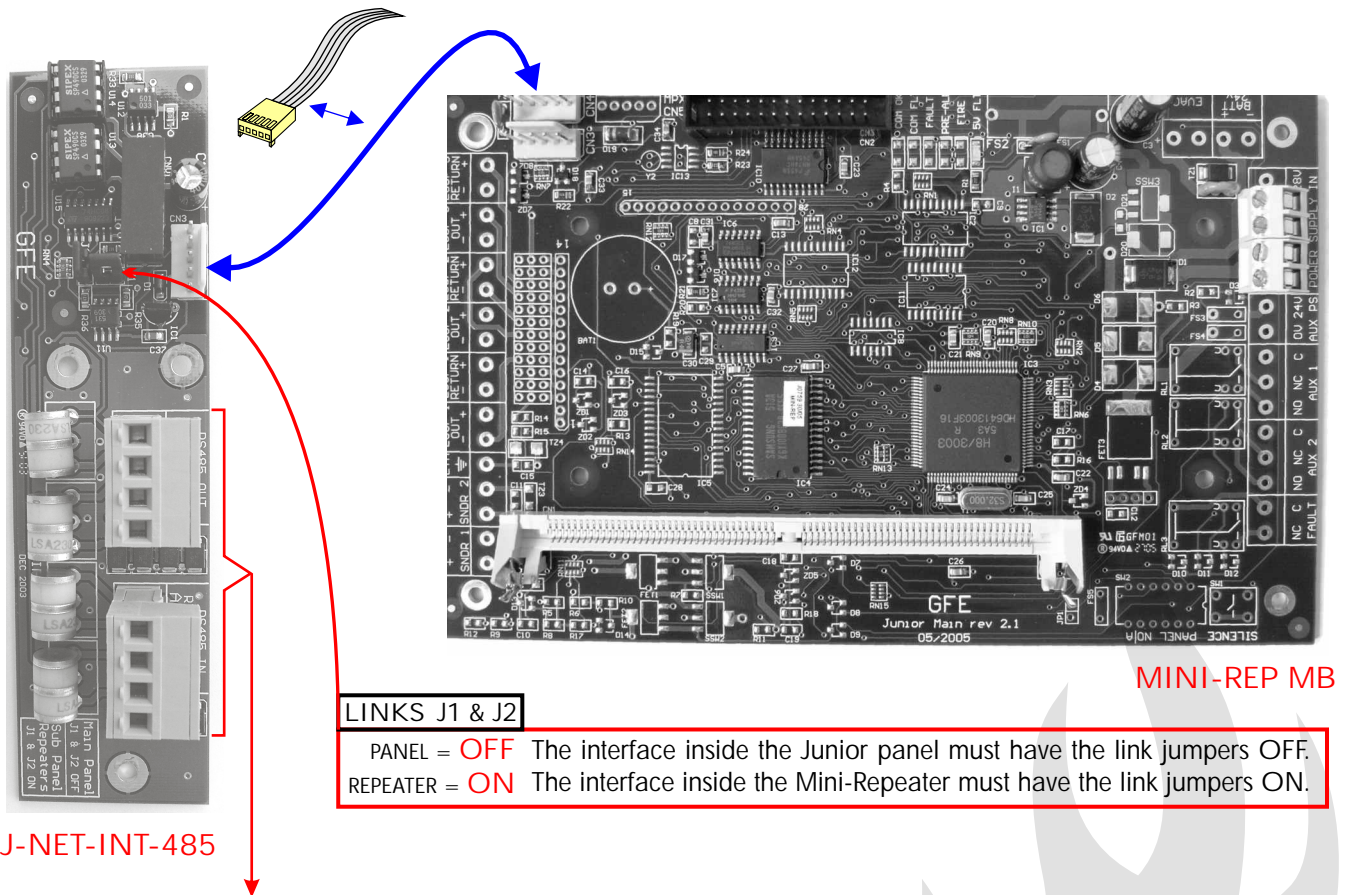

RS485 External Connection

The 4 wire external RS485 connections should be made as follows:

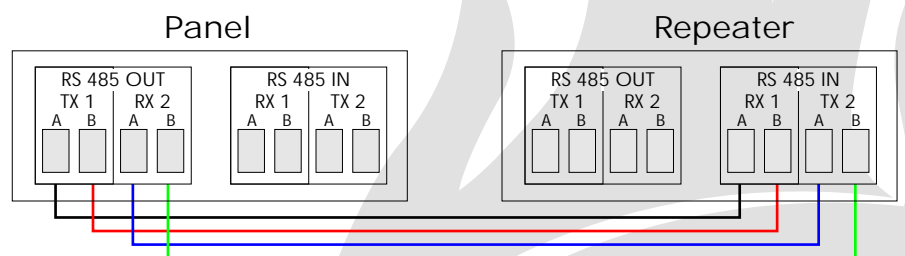
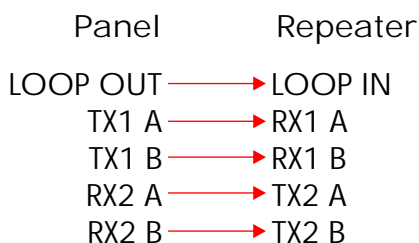

Then continue to connect OUT of one Repeater to IN of the next Repeater following the same connection rules as above. When you reach the last Repeater in the loop make the connections as follows:

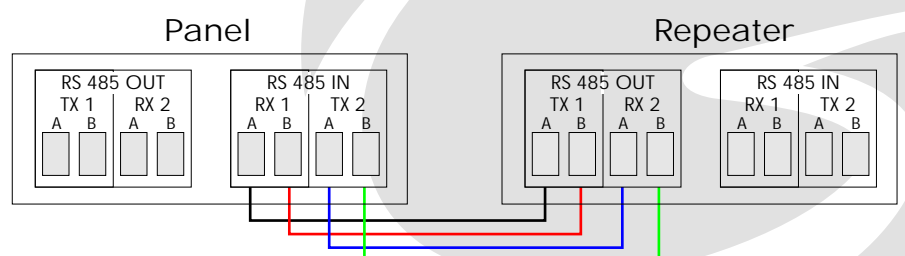
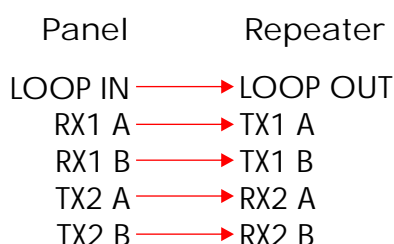

INSTALLATION

Panel Fiber-Optic

NOTE:

Make all connections with the power turned off to avoid risk of permanent damage to the circuit boards.

Connection is made using fibre optic cable instead of copper cable. The ends of the fibre must be terminated with ST™ type Fibre-optic connectors.

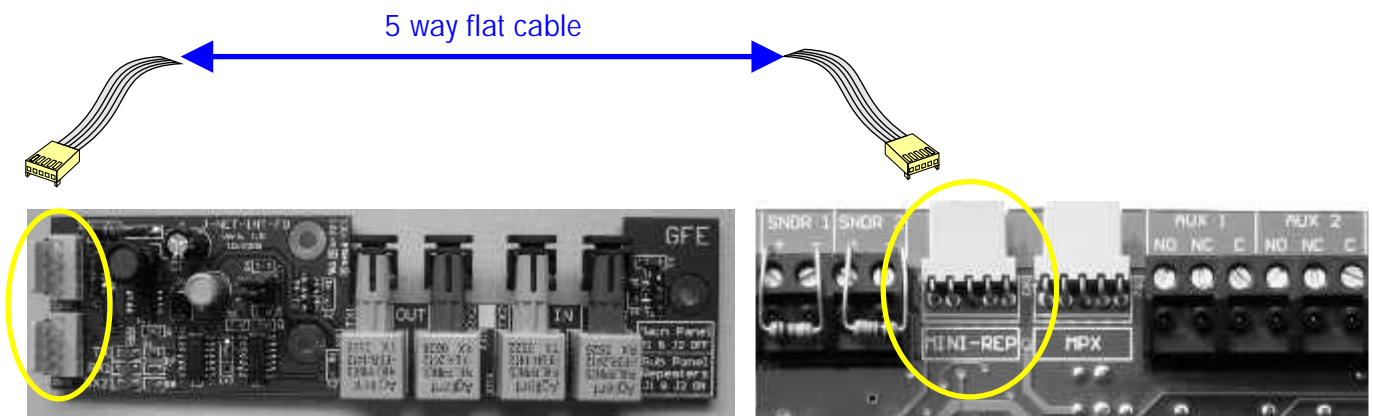

JUNIOR PANEL CONNECTIONS

LINKS LK1 & LK2

PANEL = **OFF** The interface inside the Junior panel must have the link jumpers OFF.
 REPEATER = **ON** The interface inside the Mini-Repeater must have the link jumpers ON.

Fibre-Optic External Connection

The dual fibre external fibre-optic connections should be made as follows:

Panel Mini-Repeater

LOOP OUT → LOOP IN
 TX1 → RX1
 RX2 → TX2

Then continue to connect OUT of one Repeater to IN of the next Repeater following the same connection rules as shown. When you reach the last Repeater in the loop make the connections as follows:

Panel Mini-Repeater

LOOP OUT → LOOP IN
 TX1 → RX1
 RX2 → TX2

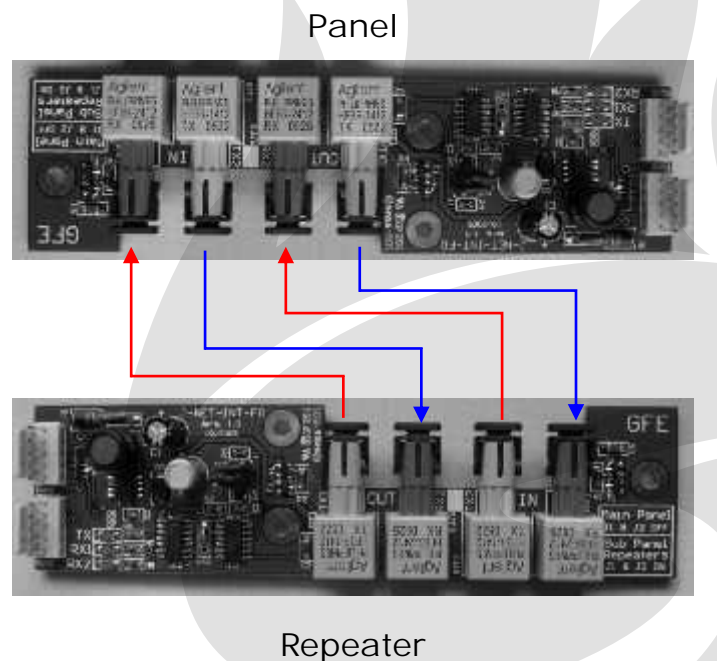

INSTALLATION

Repeater Fiber-Optic

NOTE:

Make all connections with the power turned off to avoid risk of permanent damage to the circuit boards.

The repeater connections to the Fibre-Optic Interface are basically the same as for the Panel.

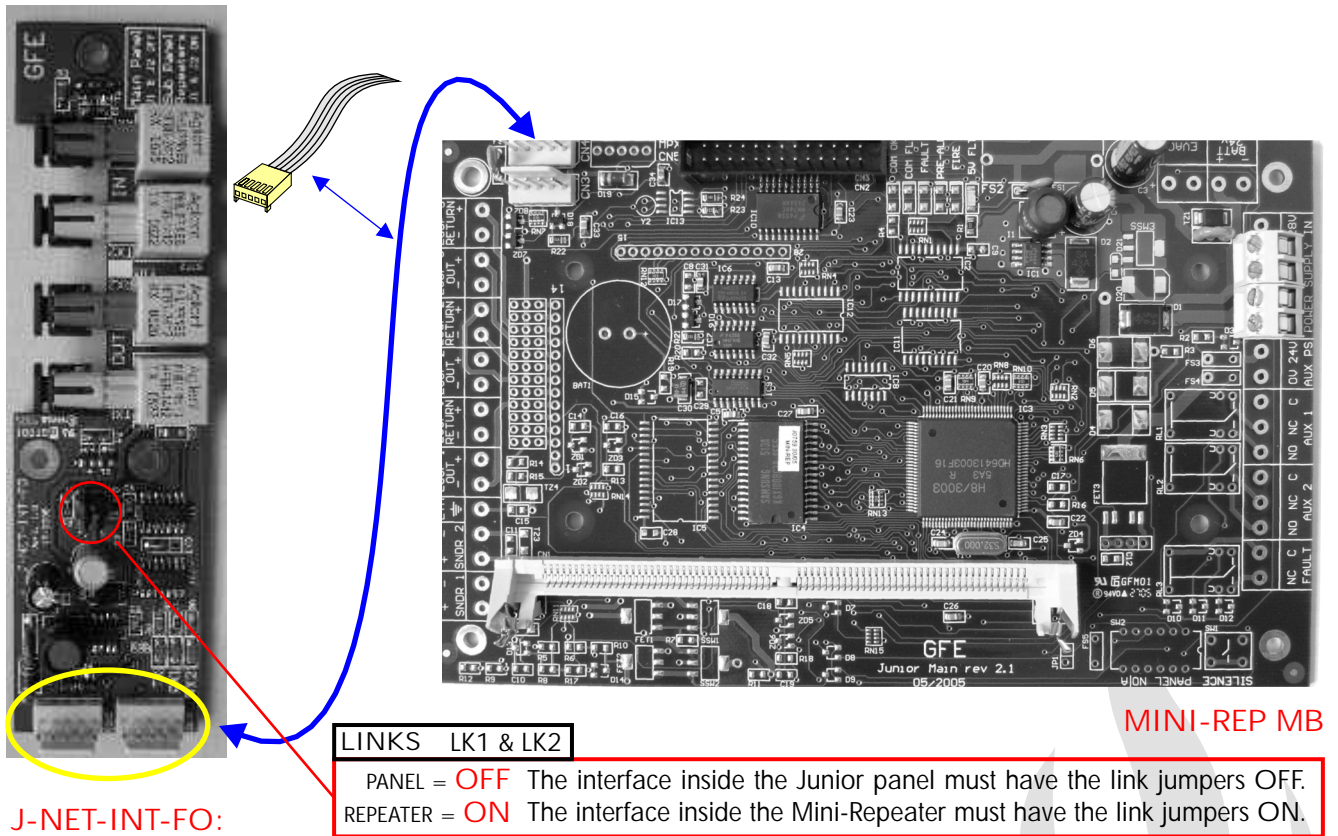

Fibre-Optic External Connection

The dual fibre external fibre-optic connections should be made as follows:

Panel Mini-Repeater

LOOP OUT → LOOP IN
 TX1 → RX1
 RX2 → TX2

Then continue to connect OUT of one Repeater to IN of the next Repeater following the same connection rules as shown. When you reach the last Repeater in the loop make the connections as follows:

Panel Mini-Repeater

LOOP OUT → LOOP IN
 TX1 → RX1
 RX2 → TX2

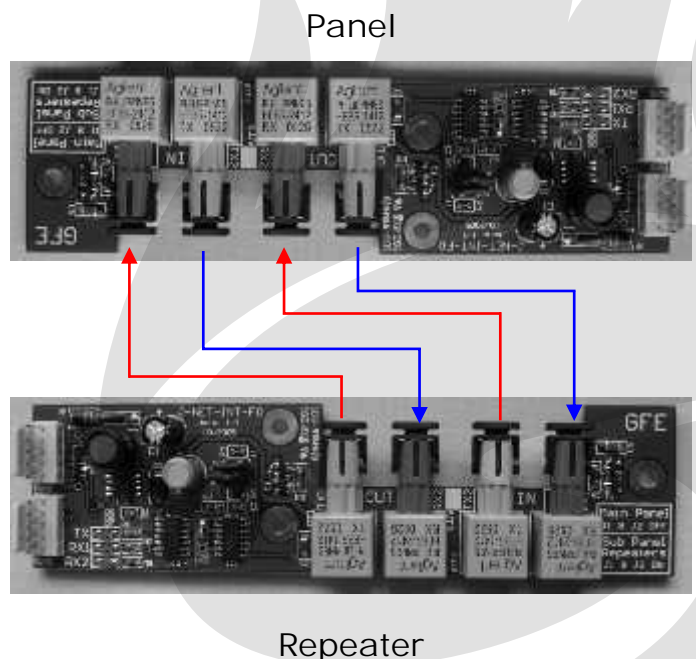

INSTALLATION

TCP/IP Connection

The use of a TCP/IP network may require the support and co-operation of the end users IT department. Be sure that this support is available before deciding on this communications method



For detailed TCP/IP connection information please refer to TCP/IP specific technical information and/or contact technical support at techs@globalfire.pt

Analogue Loop(s)

The Analogue Loop provides the connection to all the analogue addressable devices and loop powered sounders. Unless the loop is completed the panel will not be able to monitor its integrity (open and short circuit monitoring). Connection to the Analogue Loop for the Junior panel is shown below:

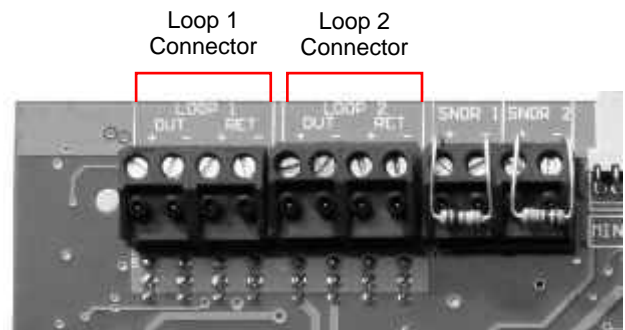

Devices that can be fitted to the Analogue Loop include smoke sensors, heat sensors, Zone Monitor Units (ZMU), I/O units, loop sounders and manual call-points. Wire the loop as shown.

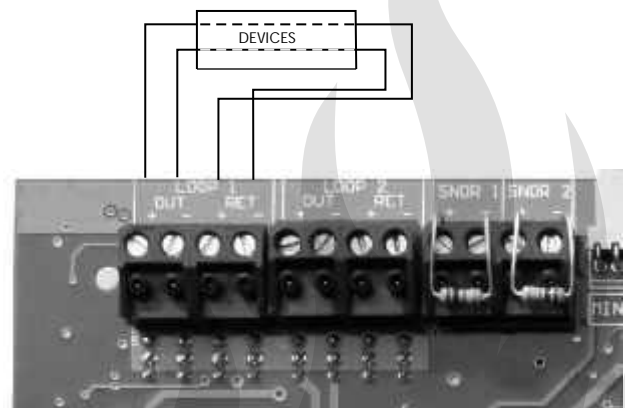

Make the connections to the devices as specified on the device data sheet. If no data sheet is available make the connections as below:

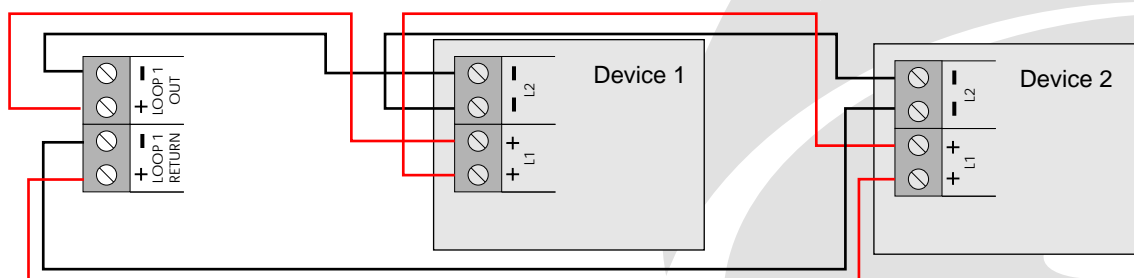

NOTE:

A maximum of 32 manual call-points can be fitted to the loop. If this value is exceeded the response time for certain types of call-point will be excessive.

INSTALLATION

Conventional Sounders

Conventional Sounders is the term used to describe conventional alarm sounders (or bells) connected directly to a Panel.

Loop-powered Sounders are different and are connected to the Analogue Loop.

Two Conventional Sounder circuits are provided on the Panel. More than one Conventional Sounder may be connected to each circuit. Max. Current rating/Output is 500 mA b@ 27.5 V DC nominal.

All Conventional Sounder circuits are monitored for open and short circuit faults. If a Conventional Sounder output is not used, then a 10K resistor must be connected across its output terminals.

WARNING: The total current load of all detection loops, sounder circuits and auxiliary supply outputs should not exceed the maximum power rating of the panel. Please refer to the technical specification tables.

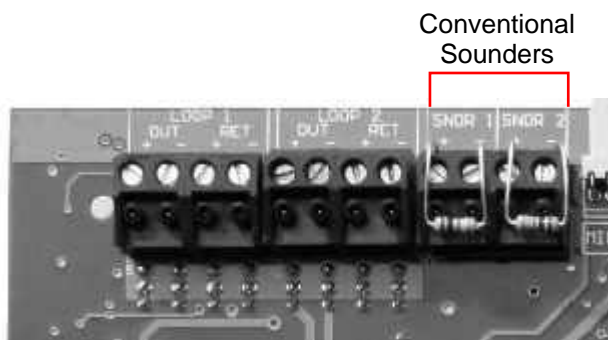

Auxiliary Fire Relays (2) and Fault Relay (1)

Two auxiliary fire relay outputs are provided on the JUNIOR Main board. These outputs are activated when a fire is detected (unless specifically inhibited). They are labeled AUX1 and AUX2. Under the presence of any Fire Alarm condition, these 2 relays will be energized. Both set of contacts are of the change-over type. Max. Contact current rating for each set of relay contacts is 1 Amp @ 50 V AC/DC resistive.

One auxiliary fault relay output is also provided. This relay output will remain closed while there are no faults present in the system. Under any fault condition present, the relay will be deenergized and the relay contact will be open. The Fault relay is NC, will open on any fault on the system.

The contact ratings are : 1A, 50V AC/DC (min 100mA, 6V)

WARNING: Relay outputs are not supervised. Please ensure that any wiring connected to these outputs is power limited.

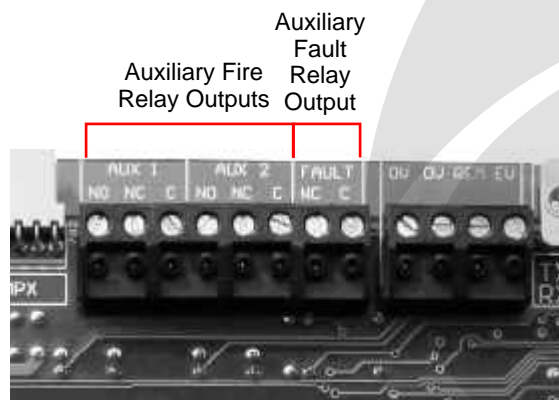

INSTALLATION

Panel Batteries

It is recommended that the batteries are fitted at the end of commissioning the system otherwise it can be difficult to remove the power quickly if there is a problem.

The batteries are connected to the JUNIOR main board in the Panel. This battery connection not only supplies the panel with power if the primary supply should fail, it also provides a charging output to maintain the batteries in a fully charged state.

Before connecting the batteries check the voltage across the battery connection terminals. It should be 27.5V +/- 0.5V.

NOTE:

Arcing and fire risk. Never short circuit the battery terminals. Always connect the blue wire between the batteries last.

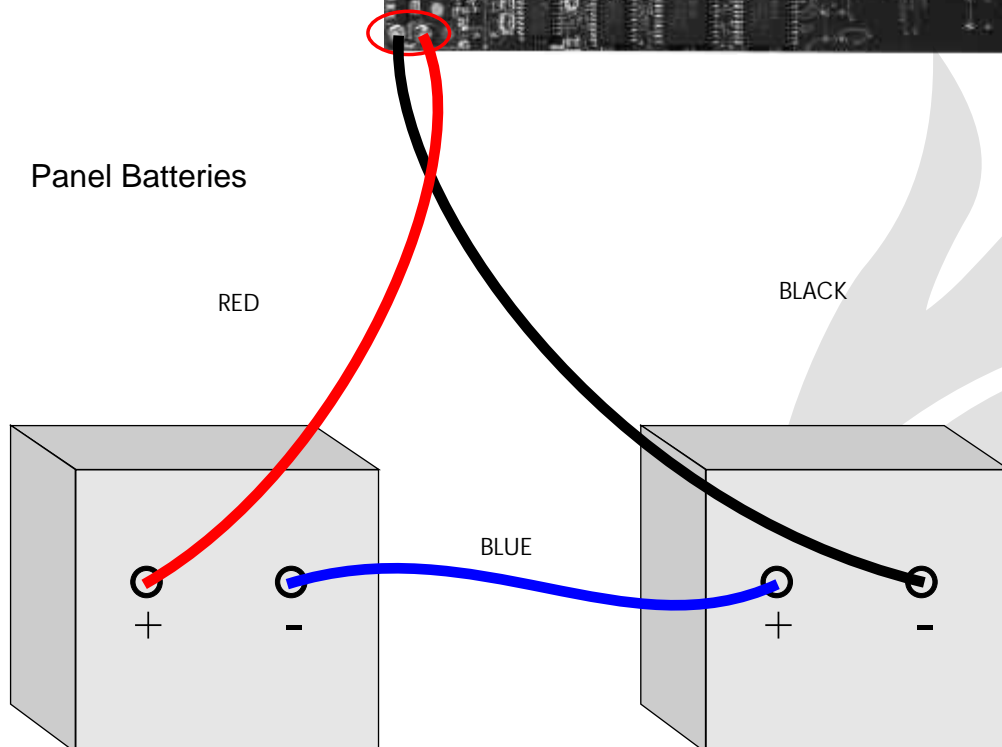
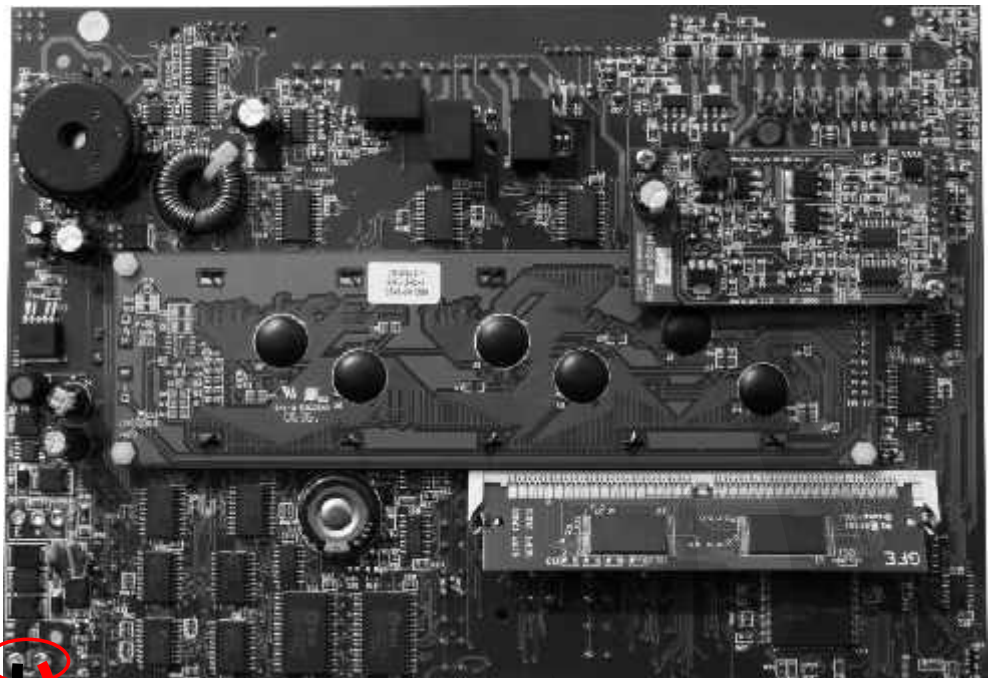

COMMISSIONING

Introduction

Commissioning involves checking that all connections have been made properly and that all hardware is functioning correctly. This means the system must first be installed in accordance with the previous section of this manual.

The panel is supplied set to 'Installation mode'. In Installation Mode the green SYSTEM ON LED will flash on and off. The panel will automatically detect and memorize all the devices connected to the loop in the system.

The default settings of the system mean that the unit will be ready to operate and detect a Fire incident from the moment power is switched on. Therefore, the system will be fully functional without any additional setting up. All further actions will tailor it to the requirements of the specific installation at hand.

Once the connections and hardware have been checked it is possible to get the basic fire alarm system up and running very quickly - it is only necessary to have the system in Installation Mode for 90 seconds then set the system to 'Active Mode'. Programming of the system to provide more advanced functionality is covered in the next section.

The Panel Buttons

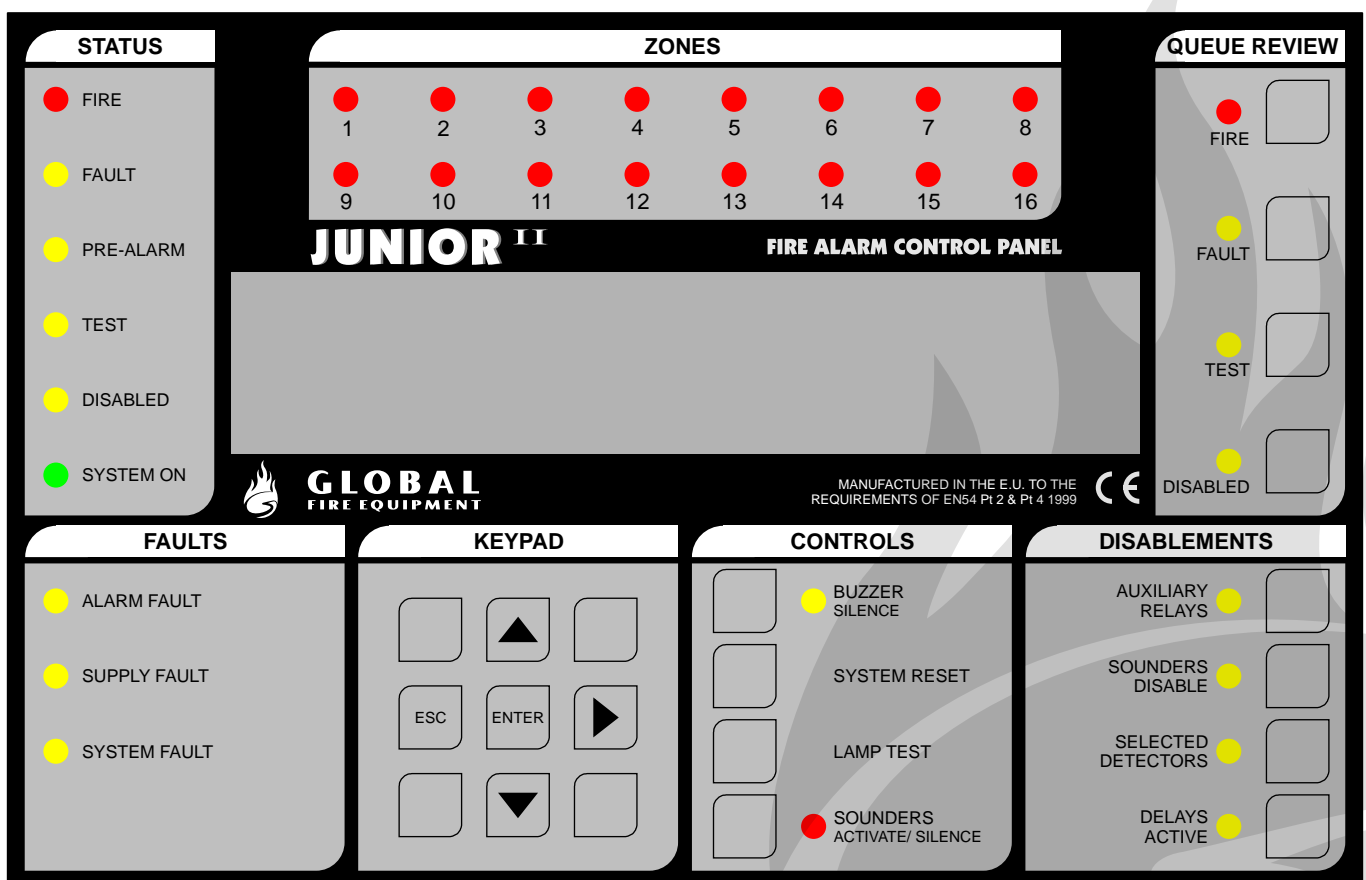

COMMISSIONING

The Panel Buttons

BUZZER SILENCE (CONTROLS)

The occurrence of any new fire or fault condition will initiate the operation of the internal buzzer. By pressing this switch, the operation of the buzzer will be stopped until a new fire or fault appears on the system.

SYSTEM RESET (CONTROLS)

Soft resets the entire system. A soft reset should be satisfactory under almost all circumstances however a Master Reset can be performed by cycling the power on the Panel (removing both primary AC and secondary DC supplies).

NOTE:

If an alarm has been detected it is necessary to silence the alarms using SOUNDER SILENCE before the SYSTEM RESET button will operate.

LAMP TEST (CONTROLS) - General User Access (no code entry required)

Lights all the LEDs, turns on the LCD back light and sets all display pixels to black. Lamp test only operates whilst the key is depressed.

SOUNDERS ACTIVATE / SILENCE (CONTROLS)

Activates all sounders. A second press de-activates all sounders.

The adjacent LED is illuminated whilst the sounders are activated.

It is possible to define if pressing the SOUND ALARMS button will activate the systems Fire I/O's.

AUXILIARY RELAYS (DISABLEMENTS)

When this button is activated all relays and I/O modules connected to the system have their outputs disabled. This includes the normally energised FAULT relay, the FAULT I/O group and all ALARM I/O groups. When these outputs are disabled the button LED is illuminated. Pressing the button again restores normal relay and I/O module operation.

NOTE:

IF I/O'S ARE TO BE ACTIVATED BY EVAC. CONDITION, THIS WILL OVERRIDE THE DISABLEMENT

SOUNDERS DISABLE (DISABLEMENTS)

When this button is activated, all sounders will be disabled and the LED will be lit. Pressing it again will reenable the sounders and the LED will turn off.

SELECTED DETECTORS (DISABLEMENTS)

Via the programming menus individual sensors may have selective disablement turned on. When this button is activated those sensors that have selective disablement turned on will not generate a fire alarm condition. When activated the adjacent LED is illuminated.

If no devices have selective disablement turned on, then pressing this button will have no effect.

Pressing the button again restores normal sensor operation.

DELAYS ACTIVE

Only when this button is activated (and the adjacent LED illuminated) will the sounder and I/O module delays operate.

Pressing the button again will deactivate the delays and will result in immediate sounder and I/O operation.

Under any fire condition the delays will be activated. If during the course of these delays this button is pressed the delays will be overridden and the sounders and together with any other fire indicating equipment, will be activated.

COMMISSIONING

The Panel Buttons (cont...)

FIRE (QUEUE REVIEW) - General User Access (no code entry required)

If more than one fire has been detected then the LED next to this button will flash. Press the button to step through all detected fires. Once all fires have been reviewed the LED will be constantly illuminated. Subsequent fires will be added to the end of the queue and the LED will start to flash again.

After each button press the information will be displayed for 20 seconds. After that time the screen will revert back to the first fire.

FAULT (QUEUE REVIEW) - General User Access (no code entry required)

If more than one fault has been detected, or if a fault and fire have been detected, then the LED next to this button will flash. Press the button to step through all reported faults. Once all faults have been reviewed the LED will be constantly illuminated. Subsequent faults will be added to the end of the queue and the LED will start to flash again.

After each button press the information will be displayed for 20 seconds. After that the screen will revert back to the first fault (or fire).

TEST (QUEUE REVIEW) - General User Access (no code entry required)

If the LED next to this button is illuminated then a test mode has been selected via the programming menus. Pressing the button will show which sounders and zones have been set to test mode. If there are more zones under test than can be displayed then pressing the button again will show the next set of zones under test.

The information is displayed for 15 seconds before the default display is restored.

NOTE:

A SYSTEM RESET will clear all test modes.

DISABLED (QUEUE REVIEW) - General User Access (no code entry required)

If the LED next to this button is illuminated then there is at least one disablement active in the system. Pressing the button will display the disablements. If there are more disablements that can be displayed then pressing the button again will show the next set of disablements and so on.

The information is displayed for 15 seconds before the default display is restored.

Possible disablements include - auxiliary relays, loops, zones, detectors and sounders.

COMMISSIONING

Getting The Panel Running

Apply AC power to the Panel.

The LCD should display the software version and the message 'INITIALIZING'. This will be followed by the date and time (and the company name if it has been set). Within a few seconds faults will be reported, these will overwrite the date and time (and company name).

The SYSTEM ON LED on the fascia of the panel should be flashing green. This indicates that the system is in Installation Mode. If the LED is solid green the system is in Active Mode and needs to be put into Installation Mode - refer to the programming section for details on how to do this.

If the SYSTEM ON LED is flashing and information is being displayed on the LCD then the Panel is functional.

If the SYSTEM FAULT LED is lit and a continuous tone is audible then remove power and confirm that the SIM CARD is fitted correctly.

Getting A Repeater Running

The supply to the repeater is obtained directly from the auxiliary power supply output on the panel. Apply power to the repeater.

If the panel is powered up and the data loop connections between panel and repeater(s) are properly made, the information shown on the LCD display as well as the LED indicator status from the panel will replicate itself on the repeater.

Press the SYSTEM RESET switch and you should see on the LCD display the message "JUNIOR" as well as the software version number, followed by the word, "INITIALIZING".

If after a few seconds upon completion of the initialization phase the LCD display shows the message, "NO COMMS TO PANEL" and the FAULT Led is lit-up, verify the condition of the panel. If it is powered up and working properly then verify the data loop connections.

If the SYSTEM FAULT LED is lit and a continuous tone is audible then remove power and confirm that the SIM CARD is fitted correctly.

COMMISSIONING

Getting Into Programming Mode (Access Level 3)

When the Panel is powered up it will be necessary to enter the panel programming mode. Familiarize yourself with this section before proceeding to the next section in the manual and powering up the panel.

Programming mode is accessed via the front panel keypad as pictured below.

To program device and zone text messages, it is essential to use the Loader PC based software.

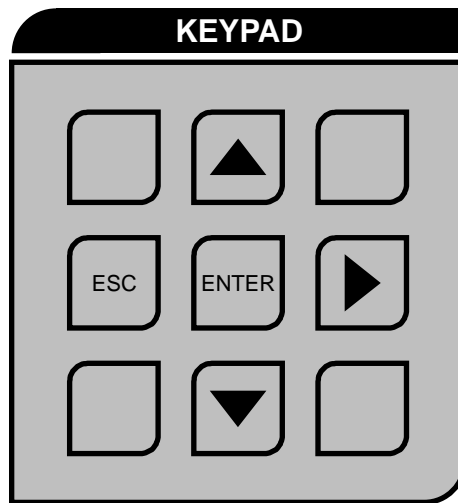

COMMISSIONING

Logging In



To enter programming mode you need to log in.

The Panel must be powered up and must have initialized itself i.e. NOT be showing the 'INITIALIZING' message.

Press ENTER on the Keypad. You must now input your Installer access code. See page 6 Access Levels. You have unlimited attempts but if code entry is not started within 10 seconds then the panel will revert back to it's default screen. While entering the code you are allowed up to 5 seconds between key presses.

Function Selection

The programming functions are arranged using a menu system.

To select a function or sub-menu use either   and ENTER. ESC takes you up a menu level.

When required use the  to toggle between loops 1 and 2.

The top level menus are:

- 1 Review Historic Log
- 3 Zones - Disable & Assign
- 4 Sounders - Disable & Assign
- 5 Input/Output - Disable & Assign
- 6 Device Set-up
- 7 Monitor Device Counts & Test
- 8 General

Most functions operate in a consistent manner using the standard keys. The item that is being changed is usually highlighted with a flashing cursor.

COMMISSIONING

Getting The System Running

Ensure all connectors are firmly in place. Ensure that all connections are tight, with no stray strands of wire. Ensure that the SIM CARD is securely fitted in the Panel and Repeaters. If a Junior Expansion Loop Card has been added to the panel, please ensure that is securely fitted to the back of panel's Main Board.

Power up the Panel.

Ensure that the Panel is in Installation Mode (SYSTEM ON LED flashing). If not, enter programming mode and select function 8-4-1 Active/Installation Mode and put the panel into Installation Mode.

Press SYSTEM RESET.

Communications Check

Confirm that all Repeaters are showing identical information (LEDs and LCD) to that displayed by the Panel.

Panel Check

Press and hold LAMP TEST on the Panel.

All the LEDs should light, the LCD backlight should turn on and all pixels on the LCD should be black. (See page 28 Lamp Test)



COMMISSIONING

Learning Which Devices Are Fitted

Enter programming mode. (See page 6 Access Levels, Installer Access Code)

If site specific data has NOT been pre-programmed then select function 8-3-1 Clear Customer Flash Memory and clear the customer flash. (You must NOT do this if you have been supplied with a SIM CARD pre-programmed with your site data.)

Select function 8-3-2 Clear Non-Volatile RAM and clear the NVRAM.

Exit Programming mode.

Press SYSTEM RESET.

Wait 90 seconds for the system to automatically learn which devices are present and report any faults.

(A SYSTEM RESET or Master Reset in Installation Mode results in an analogue loop power off period of 8 seconds [reset], an analogue loop charge up of 15 seconds then commencement of loop polling.

Review the faults (using the FAULT (QUEUE REVIEW) key if there is more than one). Note down the messages then remove power and rectify the faults.

Power up the system, let it initialize and enter programming mode.

Select function 7-1 Device Count, Type and Value

Use to select the device confirm that all devices are present. If a Junior Expansion Loop Card has been added to the panel, use the to select Loop 2 and verify the presence and proper operation of all devices fitted to this loop.

Once all faults have been cleared and the system has been in Installation Mode for 90 seconds then the system can be put into Active Mode.

Note that there is no clear end to Installation mode because the system is constantly looking and learning. However if the system is put into Active Mode and Installation Mode hasn't had time to identify all system components you will very quickly be greeted with error reports regarding unexpected devices.

If devices are ever removed, replaced or added then Installation Mode must be selected so that the system can learn the new configuration. If you do not do this the system will report a fault.

NOTE:

New SAM's (Self Addressable Modules) need a different installation process because they need to be assigned addresses before the panel can learn that they are present. This procedure is covered later in this manual in the section entitled "6-4 Automatic Address Setting (SAM)".

Sounder Audibility Check

If the building is unoccupied then press SOUND ALARMS. All sounders should operate until the button is pressed again. Confirm that this is the case.

Note that Apollo loop sounders may take a second or two to respond.

If the building is occupied it is strongly recommended that the test sounders functions in programming mode are used. Enter programming mode and select 7-2 Test Sounders. Using this function, all the sounders can be checked.

The Panel Conventional and Loop Sounders will sound for 1 second then be silenced for 9 seconds.

COMMISSIONING

Analogue Loop Monitoring

Check that a short circuit or open circuit is detected on any of the Analogue Loops.

Open Circuit Test

Disconnect either the + or the - OUT connection for the Loop. The connection is found on the Panel's Main board.

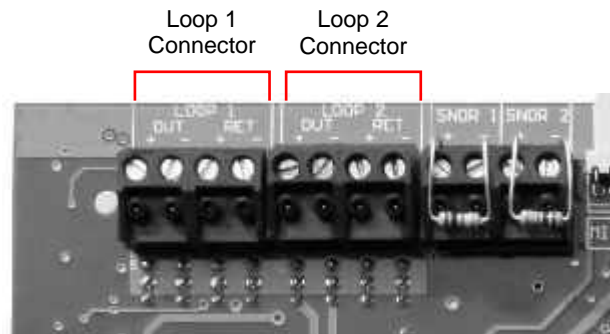

NOTE:

Loop 2 is only available if a Junior Expansion Loop Card has been fitted at the back of the panel's Main Board.

Within a few seconds, a circuit fault should be reported. No individual detector faults should be reported.

Reconnect the wires and press SYSTEM RESET to clear the fault reports.

Conventional Sounder Monitoring

Panels have two Conventional Sounder circuits.

Check the Conventional Sounder circuits for open and short circuit fault detection.

To perform the Open-Circuit test, disconnect either the + or - connection at each conventional sounder circuit.

To perform the Short-Circuit test, connect for each sounder circuit a wire link, connecting both the + and - terminals together.

With either test, after a few seconds, a fault message will appear on the LCD display of both the panel and repeater(s) indicating that the conventional sounder circuit is at fault.

Both the FAULT and ALARM FAULT Led indicators will be lit.

Restore the original connections and press SYSTEM RESET to clear all the error reports.

WARNING: if the Conventional Sounder outputs are short circuited while the sounders are active, the electronic overload protection is tripped and the system will report a sounder fault illuminating the ALARM FAULT LED simultaneously. Once the short circuit is cleared, a system reset will clear the faults.

COMMISSIONING

Detector Tests

If the devices have been assigned to Zones (on a pre-programmed SIM CARD or via the programming menus) then it is possible to test the detectors with limited or no sounder operation.

Detector Tests By Zone

Before starting clear all faults, put the system into Active Mode, and press SYSTEM RESET.

Enter programming mode and select function 7-3 Sounders on Test Activation. This allows you to choose an audible confirmation that a device has detected a fire. The audible confirmation consists of a 1 second period of sounder operation.

ALL SOUNDERS ON DETECTOR TEST activates the Panel Conventional and Loop Sounders.

Now select function 7-4 Test Zones to select the Zones which will be tested.

Exit programming mode, but DO NOT press SYSTEM RESET as this clears all test modes.

In test mode whenever a detector is activated the LED on that detector will be illuminated and the event will be reported on the panel for 15 seconds. If selected, the sounders will also operate for 1 second.

Pressing TEST (QUEUE REVIEW) will report the Zones that are in Test Mode.

Unassigned Detector Tests

If the detectors have not been assigned to a Zone then they can only be tested in normal (Active) mode. Using the programming menu ensure the system is set to Active Mode then exit programming mode and press SYSTEM RESET.

Carry out a fire test on each detector. Confirm the LED lights on the detector under test. Confirm that the fire is reported correctly at the Panel (and any Repeaters). Confirm that the sounders operate.

Note that sounders and detectors can be inhibited or delayed using the advanced features in the programming menus. If the sounders do not operate as expected first verify all the settings for the sounders and the device under test.

Wrapping Up Installation And Commissioning

At this stage you may program the more advanced features of the system. The basic minimum usually involves assigning text labels to the device and Zones.

Once you have completed this or if you have a pre-programmed SIM CARD then do not forget to carry out the following steps:

Connect the batteries to the Panel as described in the Installation section of this manual.

Test that the battery monitoring is functional by temporarily removing the blue wire between the batteries. After a few seconds the fault should be reported on the Panel.

When the blue wires are reconnected pressing SYSTEM RESET should clear the fault report.

Test that the primary supply monitoring is functional and that the battery system works. Switch off the AC supply to each power supply unit in the Panel. After a few seconds the fault should be reported on the Panel.

Reconnect the AC supplies and press SYSTEM RESET.

Confirm that the system is in Active Mode - the SYSTEM ON LED is permanently lit.

COMMISSIONING

Battery Fault Message Test

This test should be performed for each set of batteries. Test only the actual battery connections.

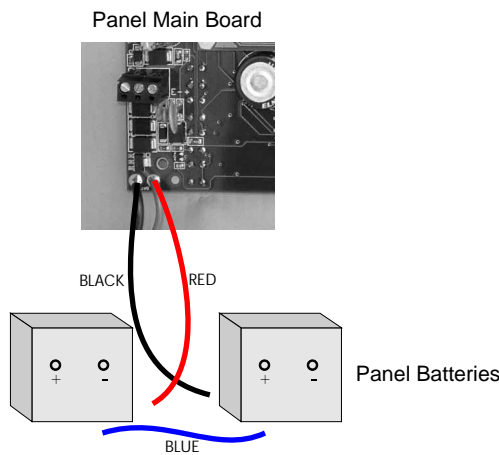

Remove the blue link from between the 2 batteries

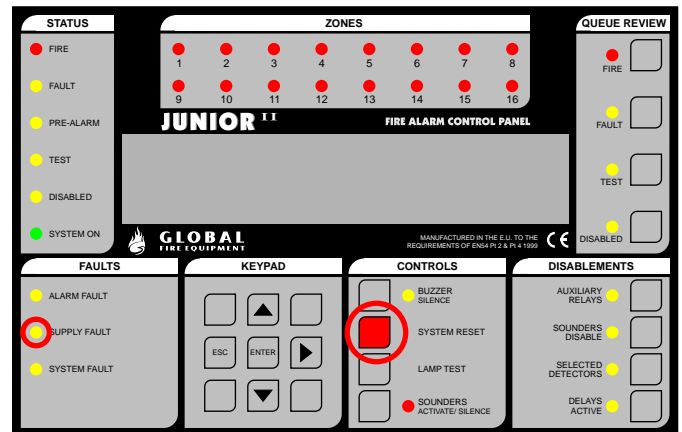
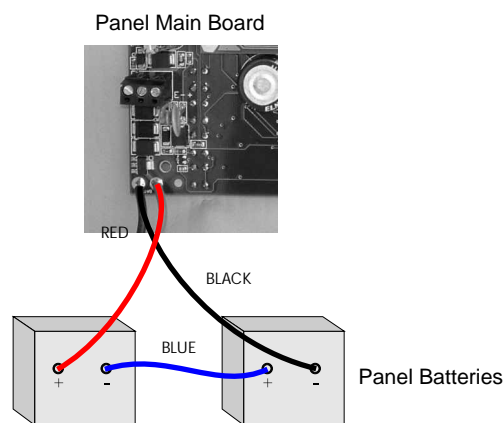

After a short delay, the SUPPLY FAULT LED illuminates, the panel buzzer sounds and the "Battery Fault" message appears on the LCD

Replace the link between the batteries and reset the panel (SYSTEM RESET) to clear the fault indication.

Power Failure Test

Carry out this test to check that the battery system works correctly when power fails.

Switch off the mains supply to the panel. After a short delay, the SUPPLY FAULT LED illuminates amber and the LCD displays the message "Primary Supply Fault". The fault buzzer sounds.

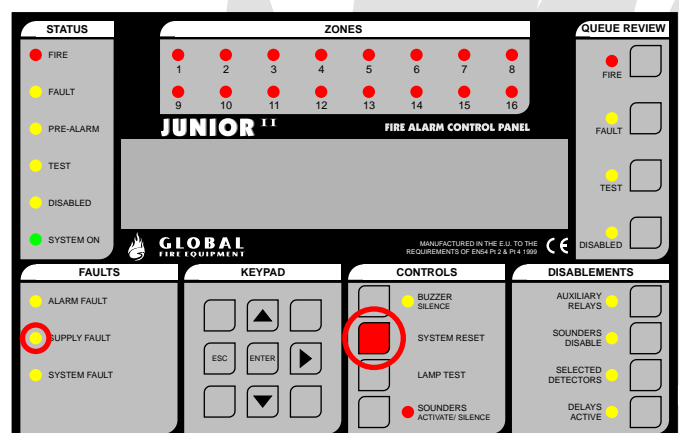

Switch the mains supply back on and press the SYSTEM RESET switch. The SUPPLY FAULT LED extinguishes, the fault message is removed from the LCD, and the buzzer stops sounding.

ADVANCED
FUNCTIONALITY

Programming Functions General

1 Review Historic Log

- 1-1 Display Historic Log
- 1-3 Clear Historic Log
- 1-5 Read/Clear Autostart Count

3 Zones - Disable & Assign

- 3-1 Disable Zones
- 3-2 Assign Sounder Groups to Zones
- 3-3 Assign I/O Groups to Zones
- 3-4 Assign Zone to Device
- 3-5 Zone Sounder Delay Set-up

4 Sounders - Disable & Assign

- 4-1 Sounder Configuration
- 4-2 Configure Sounder Groups
- 4-3 Disable Sounders
- 4-4 Assign Sounder Group to Device
- 4-5 Inhibit Sounders for Device
- 4-6 Sounder Delay Set-up
- 4-7 Override Sounder Delays

5 Input/Output - Disable & Assign

- 5-1 Configure I/O Groups
- 5-2 Select Fault I/O Group
- 5-3 Assign I/O Group to Device
- 5-4 Inhibit I/O for Device
- 5-5 I/O Unit Action upon Evacuate
- 5-6 I/O Unit Delay or Immediate
- 5-7 I/O Delay Set-up

6 Device Set-up

6-1 General

- 6-1-1 Disable Loops
- 6-1-2 Device Disable
- 6-1-3 Set Selective Disablement
- 6-1-4 Set Device Reporting Details
- 6-1-5 Set Immediate Evacuate for Device
- 6-1-6 Device Activation Overrides Delays
- 6-1-7 Inhibit Auxiliary Relays
- 6-1-8 Global Sensitivity Set-up
- 6-1-9 Configure Timed Sensitivity

6-2 Other Device Options

- 6-2-1 Select Device Heat Grade
- 6-2-2 Select Device Smoke Sensitivity

6-3 Discovery Specific - Functions only available for panels programmed to use Apollo Discovery Protocol

- 6-3-1 Select Device Sensitivity Mode
- 6-3-2 Flashing Leds On/ Off
- 6-3-3 Disable Specific Flashing Leds
- 6-3-4 Re-calibrate All Devices
- 6-3-5 Check for Devices Needing Service
- 6-3-6 Read Data Stored in Device
- 6-3-7 Write Data Stored in Device

6-4 Automatic Address Setting (SAM)

- 6-4-1 Activate ASET Mode (SAM)
- 6-4-2 Clear Loop
- 6-4-3 Clear Device

7 Monitor Device Counts & Test

- 7-1 Device Count, Type & Value
- 7-2 Test Sounders
- 7-3 Sounders on Test Activation
- 7-4 Test Zones
- 7-6 Light LED on device

8 General

8-1 Time/Date & Timers

- 8-1-1 Set Date & Time
- 8-1-2 Define Day & Night
- 8-1-3 Delays Off at Night
- 8-1-4 Configure Evacuate Timer
- 8-1-5 Device Starts Evacuate Timer

8-2 Special Features Set-up

- 8-2-1 Two Devices to Evacuate
- 8-2-2 Call Points to Evacuate

8-3 Memory - BEWARE, ENGINEERS ONLY

- 8-3-1 Clear Customer Flash Memory
- 8-3-2 Clear Non-Volatile RAM
- 8-3-3 Calculate Customer Flash Checksum
- 8-3-4 Calculate Program Flash Checksum

8-4 Other Features

- 8-4-1 Active/Installation Mode
- 8-4-2 Upload/Download Link to PC
- 8-4-4 Set User Access Code
- 8-4-5 Set User Functions
- 8-4-6 Select language
- 8-4-8 Set Installer Access Code

ADVANCED
FUNCTIONALITY

Keys To Use Within Functions

Most functions use some or all of the following keys:

are used to browse through items

◆ is often used to change fields (move the cursor). It will also be used, when required to toggle between Loops 1 and 2.

ENTER is used to select items and store changes

ESC is used to abort changes and exit

The cursor is often shown to highlight the item that is being changed.

Help

Where possible, help is displayed automatically.

General

Because of the flexibility and functionality of this panel it can sometimes be quite hard to establish your desired configuration. Zone, device and group events interact as do the various timers.

If the system does not seem to operate as intended please take your time and review the various sections in this manual. Some settings need the front panel buttons to be activated whilst others can be inhibited for specific devices.

The basic functionality of the panel is readily available and the fire alarm system will be operational just by supplying it with electrical power. Exercising cause and effect capability is what this section is all about. The best way to become familiar with all the programming facilities of this panel will be a hands-on approach aided closely by this manual.

NOTE:

If a fire occurs whilst the panel is in programming mode then programming mode will automatically be exited. If a fault occurs whilst in programming mode the fault will be reported but it is necessary to manually exit programming mode to read the fault details on the LCD.

Specific Functions

1 Review Historic Log

All the functions associated with reviewing or printing events and settings.

1-1 Display Historic Log

The panel logs all events in an internal event log. It can store a rolling 2000 entries. When it is full the latest entry is added and the oldest entry discarded.

Help is automatically displayed on entry to the function because it is not possible to display a log entry and help at the same time.

To select a specific entry, input the number and then press ENTER.

1-3 Clear Historic Log

Clears the Historic Log.

1-5 Read/Clear Autostart Count

Every time the Panel's power is cycled, the Autostart count is incremented. SYSTEM RESETs from the front panel button do not increment the Autostart count.



3 Zones - Disable & Assign

All the functions associated with managing Zones

3-1 Disable Zones

Allows you to disable or enable Zones.

All devices in disabled Zones will cease to operate with the exception of the (audible) output from loop sounders.

Any Zones that are disabled will also be indicated when programming mode is exited. They can then be reviewed using the DISABLED (QUEUE REVIEW) button.

3-2 Assign Sounder Groups to Zones

Sounder Groups (set up using the Sounders programming functions) can be assigned to Zones.

Each Zone can be assigned two sounder groups. The first Sounder Group is activated when the first fire is detected, the second Sounder Group is activated when a second fire is detected in the same Zone.

3-3 Assign I/O Groups to Zones

I/O Groups (set up using the I/O programming functions) can be assigned to Zones.

The first 4 I/O groups are activated when the first fire is detected, the 5th I/O group is activated when a second fire is detected in the same Zone.

The details of the activation are set up using the I/O programming functions.

3-4 Assign Zone to Device

Allows the detection Zone to be defined.

Select which devices make up which Zones. If a device has a text label it will be displayed. If a Zone has a text label it will also be displayed.

Up to 384 Zones can be defined.

Zone 000 is not a Zone and indicates no Zone has been assigned.

3-5 Zone Sounder Delay Set-up

Allows the sounder activation delay to be enabled or disabled for each specific Zone.

Note that this delay will only occur if the following has also been set:

- Sounder programming function 4-6: The sounder delay period is set, the delay is set to ZONAL MODE and the devices that initiate the delay have been specified.
- The front panel ACTIVE DELAYS button has been set to on (LED lit).

NOTE:

Specific devices in the Zone can be set to override this delay.

ADVANCED
FUNCTIONALITY

4 Sounders - Disable & Assign

4-1 Sounder Configuration

Allows selection of PRESET or PROGRAMMED sounder operation.

Selecting PRESET (the default) will result in all sounders being operated; any Sounder Group settings will be ignored.

NOTE:

- The Sounder Groups must be defined when PROGRAMMED is selected because the default group settings have all sounders set to silent.
- PRESET or PROGRAMMED does not affect any sounder delay settings.

4-2 Configure Sounder Groups

Allows all the Sounder Groups to be defined. A Sounder Group can consist of any combination of sounders. 512 Sounder Groups can be defined.

For each sounder:

'C' indicates continuous operation.

'S' indicates silent (no) operation.

'P' indicates pulsing operation.

Panel 00 is the Panel and corresponding Conventional Sounder outputs.

Panel 01 corresponds to the Loop Sounders in the loop.

Group 512 is the Common Sounder Group. This is always operated when Sounder Group operation is turned on and a fire occurs.

When a fire occurs all the Sounder Group information for the detector in fire is combined: the device Sounder Group is combined with the Zone Sounder Group and the Common Sounder Group. 'P' pulsing will override 'S' silent and 'C' will override 'P' pulsing.

When a subsequent fire occurs the new Sounder Group information is added to the existing Sounder Group information. 'P' pulsing will override 'S' silent and 'C' will override 'P' pulsing.

NOTE:

- If Sounder Groups are defined then it is essential to set 4-1 Sounder Configuration to PROGRAMMED, otherwise, all the system sounders will be activated by any fire event.
- Individual detectors can be set not to activate Common Sounder Groups, Zone Sounder Groups or all sounders. See function 4-5 Inhibit Sounders for Device.
- If evacuate is operated (by setting CALL-POINTS to evacuate, then activating a CALL-POINT, for example) the sounders will operate as if the sounder configuration were set to PRESET.

ADVANCED
FUNCTIONALITY4-3 Disable Sounders

Allows specific sounders to be disabled or Enabled.

Disabled sounders will not be operated regardless of Sounder Configuration, Sounder Groups and evacuate requests.

'E' indicates enabled

'D' indicates disabled

When programming mode is exited all sounders that have been disabled can be reviewed using the DISABLED (QUEUE REVIEW) button.

4-4 Assign Sounder Group to Device

Allows a Sounder Group to be assigned to a detector. When the detector goes into alarm then the assigned Sounder Group will be activated (Sounder Groups only function when Sounder Configuration is set to PROGRAMMED).

NOTE:

- When a fire occurs all the Sounder Group information for the detector in fire is combined: the device Sounder Group is combined with the Zone Sounder Group and the Common Sounder Group. 'P' pulsing will override 'S' silent and 'C' will override 'P' pulsing.
- Do not use this function to assign sounders to Sounder Groups; it will have no effect. Assign sounders to Sounder Groups using function 4-2 Configure Sounder Groups.

4-5 Inhibit Sounders for Device

Allows a device to be set so that it does not operate certain Sounder Groups. (Sounder Groups only function when Sounder Configuration is set to PROGRAMMED).

The options are:

COMMON	The Common Sounder Group (512) is not activated when the device detects fire
ZONAL	The Zone Sounder Group for the device is not activated when the device detects fire
ALL	No sounders are activated when the device detects fire

Inhibiting all sounders for a device will inhibit all sounders even if the Sounder Configuration is set to PRESET.

COMMON or ZONAL inhibits will not inhibit the Sounder Group directly assigned to a device (function 4-4 Assign Sounder Group to Device) if that device detects fire.

ADVANCED
FUNCTIONALITY

4-6 Sounder Delay Set-up

Allows the sounder delay to be set-up:

The sounder delay can be set to GLOBAL MODE, ZONAL MODE or DISABLED.

The sounder delay period is defined (to a maximum of 10 minutes).

The devices that initiate a delayed sounder activation are specified.

If the function is set to ZONAL MODE it is also necessary to set up the activation using Function 3-5 Zone Sounder Delay Set-up.

The options for initiation are:

CALL POINTS ONLY - call-points start the delay timer. The sounder groups associated with the activated call-point will be queued for delayed activation. Other devices will not start the delay timer and will activate their sounder groups immediately.

DETECTORS ONLY - detectors start the delay timer. The sounder groups associated with the activated detector will be queued for delayed activation. Call points will not start the delay timer and will activate their sounder groups immediately.

ANY DEVICE - any device will start the delay timer. The sounder groups associated with the activated device will be queued for delayed activation.

For sounder delays to operate the front panel ACTIVE DELAYS LED has to be lit.

There is only one sounder delay timer so when this expires any further sounder activations will be immediate.

If SOUNDERS ACTIVATE/SILENCE is pressed when there are sounders queued for delayed activation the queued sounders are also silenced (stopped from sounding). Once the first alarm has been silenced by pressing SOUNDERS ACTIVATE/SILENCE all subsequent fires will be reported immediately (the sounder delay settings will be ignored).

NOTE:

Specific sounders (function 4-7) and specific detectors (function 6-1-6) can be set to override this delay.

4-7 Override Sounder Delays

Allows specific sounders to activate immediately even if the system has been set with sounder delays active.

0 indicates normal operation

X indicates that the specific sounder will operate immediately

Sounders set to immediate will also override any Sounder Group settings for that specific sounder. Sounders set to immediate operation will sound continuously (pulsing settings will be overridden).

5 Input/Output - Disable & Assign

Input/Output Analogue Loop device management.

5-1 Configure I/O Groups

Allows an I/O Group to be established. The I/O Group can then be used for fire or fault reporting. 512 I/O Groups can be defined.

First select the Group number then assign the I/O loop addresses.

Each I/O Group can have up to 32 I/O units. (256 for the Common I/O Group)(Group 512).

I/O Group 512 is the Common I/O group. The Common I/O Group is always activated when a fire occurs.

When a fire occurs all the I/O information for the detector in fire is combined: the device I/O Group is combined with the Common I/O Group and the four 'first fire' Zone I/O Groups.

When a subsequent fire occurs in the same Zone the 'second fire' Zone I/O group is activated.

Upon a fire the I/O operations are cumulative.

NOTE:

Specific devices can be set not to activate I/O (including Common I/O) - function 5-4 Inhibit I/O for Device.

5-2 Select Fault I/O Group

Allows a specified I/O group to be activated if a fault condition occurs.

It is not recommended to use the same I/O group for fire and fault reporting.

ADVANCED FUNCTIONALITY

5-3 Assign I/O Group to Device

Allows an I/O Group to be assigned to a detector. When the detector goes into alarm then the assigned I/O Group will be activated.

NOTE:

When a fire occurs all the I/O information for the detector in fire is combined: the device I/O Group is combined with the Common I/O Group and the four 'first fire' Zone I/O Groups.

This function can be used to assign an I/O module (input) to activate an I/O Group output. The I/O Group output could be on the same I/O module, another I/O module or a group of I/O modules.

5-4 Inhibit I/O for Device

Allows a device to be set so that it does not operate certain I/O Groups.

The options are:

COMMON	The Common I/O Group (512) is not activated when the device detects fire
ZONAL	The Zone I/O Group for the device is not activated when the device detects fire
ALL	No I/O Groups are activated when the device detects fire

COMMON or ZONAL inhibits will not inhibit the I/O Group directly assigned to a device (function 5-3 Assign I/O Group to Device) if that device detects fire.

5-5 I/O Unit Action upon Evacuate

Allows you to define how an I/O module will perform when an evacuate is signaled. By default an I/O module will not activate unless it has been assigned to an I/O Group that has been activated.

NOTE:

An evacuate is not considered as an automatically detected fire event.

5-6 I/O Unit Delay or Immediate

Allows a specific I/O module to be set so that it activates immediately even if the rest of the I/O is set to be activated after a delay.

5-7 I/O Delay Set-up

Allows the I/O (output) delay to be set. This delay applies to all I/O module outputs.

The maximum delay that is allowed is 10 minutes.

There is only one I/O timer so once it has expired events activating further delayed I/O groups will cause immediate I/O operation.

NOTE:

- Delays will only occur if front panel ACTIVE DELAYS button has been set to on.
- Specific I/O modules (function 5-6) and specific detectors (function 6-1-6) can be set to override this delay.

6 Device Set-up

Allows specific settings to be selected for individual Analogue Loop devices.

6-1 General

Settings common to all types of Analogue Loop devices.

6-1-1 Disable Loops

Allows a specific Analogue Loop to be disabled or enabled. The default is enabled.

All devices on the disabled loop will cease to operate with the exception of the (audible) output from loop sounders.

If the loop is disabled it will be indicated when programming mode is exited. It can be reviewed using the DISABLED (QUEUE REVIEW) button.

6-1-2 Device Disable

Allows a specific device to be disabled or enabled. The default is enabled.

Disabled devices have both inputs and outputs disabled.

This function does not disable the (audible) output from loop sounders.

Any devices that are disabled will also be indicated when programming mode is exited. They can then be reviewed using the DISABLED (QUEUE REVIEW) button.

6-1-3 Set Selective Disablement

Allows a specific device to be set up for selective disablement.

The device is only disabled when the SELECTED DETECTORS (DISABLEMENTS) button on the front panel is activated.

This function is intended for use when certain detectors regularly need disabling but are not necessarily in the same Zone.

Outside programming mode any devices that are currently disabled can then be reviewed using the DISABLED (QUEUE REVIEW) button.

6-1-4 Set Device Reporting Details

Each device can be set to:

FIRE
FAULT
PRE-ALARM
TRANSPARENT

The default is FIRE reporting.

When the device is activated or reaches its alarm threshold then the event is reported in accordance with this setting.

FAULT - Primarily intended for use with Input modules, it can allow activation of one input to trigger a fault report rather than a fire.

PRE-ALARM - Sends warning when the level reported from a detector is 10 below the Alarm threshold. Used for early warning in sensitive applications.

Transparency Configuration is ONLY applied to Input/Output or Input units. It is not compliant to EN54.

6-1-5 Set Immediate Evacuate for Device

When a detector set to immediate evacuate reports a fire all Sounder Group settings are ignored. All sounders are operated immediately as if the Sounder Configuration was set to PRESET and all delays are ignored.

NOTE:

Disabled sounders will not sound.

6-1-6 Device Activation Overrides Delays

Allows a detector to be set to override all zonal and global sounder and I/O delay timers. When this device is activated the Sounder Groups and I/O Groups associated with this device are also activated immediately (even if they were already queued for delayed activation).

However this device will not start any of the timers either which means that subsequent fires reported from other detectors may experience the full delay duration (as programmed).

6-1-7 Inhibit Auxiliary Relays

Allows a specific detector to be set to not operate system I/O's and Auxiliary Relays when it reports a fire. (Equivalent to pressing auxiliary relays disablement button.)

ADVANCED
FUNCTIONALITY

6-1-8 Global Sensitivity Set-up

This function selects the sensitivity of all the detectors that have been set to GLOBAL SENSITIVITY.

Different settings can be entered for weekdays and for Saturday and Sunday.

Settings are :

HIGH (alarm threshold of 45)
NORMAL (alarm threshold of 55)
LOW (alarm threshold of 65)
TIMED

If TIMED is selected then the night and day sensitivity settings used are based on whether it is night or day. Set the night and day sensitivities using programming function 6-1-9. Define the time day and night start using programming function 8-1-2.

The Pre-alarm levels are always 10 below the alarm thresholds.

Ensure that the system clock day, date and time are set correctly (function 8-1-1).

Note that in order to keep day/night and day settings consistent a day setting starts at sunrise (which is set by function 8-1-2). This means that, for example, the Saturday setting will start at 8:00 AM on Saturday.

NOTE:

Smoke detectors set to LOW sensitivity do not meet the requirements of EN54 part 5.

6-1-9 Configure Timed Sensitivity

Allows the sensitivity to be set for day and night.

Settings are :

HIGH (alarm threshold of 45)
NORMAL (alarm threshold of 55)
LOW (alarm threshold of 65)

NOTE:

- Only detectors that have their sensitivity set to GLOBAL SENSITIVITY will have their sensitivity changed, and then only if 6-1-8 Global Sensitivity Set-up has the day set to TIMED.
- Smoke detectors set to LOW sensitivity do not meet the requirements of EN54 part 5.

ADVANCED
FUNCTIONALITY

6-2 Other Device Options

6-2-1 Select Device Heat Grade

This function is only applicable to Heat Detectors. It has no effect on other devices.

It allows the alarm threshold for the heat detector to be set.

The default threshold is 55 ° C.

The Pre-alarm levels are always 10° C below the alarm thresholds.

6-2-2 Select Device Smoke Sensitivity

This function is only suitable for smoke detectors.

It allows the alarm threshold for smoke detectors to be set.

Each individual detector has the following settings:

NORMAL
LOW
HIGH
GLOBAL

If GLOBAL is selected then, depending the day, the appropriate HIGH, LOW, NORMAL or TIMED setting is used (see functions 6-1-8 Global Sensitivity Set-up and 6-1-9 Configure Timed Sensitivity).

HIGH	=	45
NORMAL	=	55
LOW	=	65

The Pre-alarm levels are always 10 below the alarm thresholds.

NOTE:

Smoke detectors set to LOW sensitivity do not meet the requirements of EN54 part 5.

ADVANCED FUNCTIONALITY

6-3 Discovery™ Specific

Analogue Loop device settings that are specific to devices that support the Discovery™ communication protocol. These functions will only act on Sub-panels that are set to Discovery™ protocol.

6-3-1 Select Device Sensitivity Mode

Allows a specific operating mode to be selected for a specific device. Refer to the device data sheet for the mode definitions.

The modes usually relate to sensitivity or detection method.

Settings are MODE 1, MODE 3, MODE 5 or GLOBAL.

If GLOBAL is selected then, depending on the day, the appropriate HIGH, LOW, NORMAL or TIMED setting is used (see functions 6-1-8 Global Sensitivity Set-up and 6-1-9 Configure Timed Sensitivity).

In this context:

HIGH	=	MODE 1
NORMAL	=	MODE 3
LOW	=	MODE 5

6-3-2 Flashing LEDs On/Off

When set to FLASHING all Discovery™ devices on the system will flash their LEDs when they are polled. Only Discovery™ devices that have had the flash disabled will not flash when polled (see programming function 6-3-3).

NOTE:

When this setting is changed it is necessary to write individually to every Discovery™ device connected to the system. This can take 60 seconds. During this time do not select any Discovery™ Specific programming functions (6-3-X).

6-3-3 Disable Specific Flashing LEDs

Use this function to individually disable the LED flash when polled on Discovery™ detectors.

This setting has no effect when programming function 6-3-2 'Flashing LEDs On/Off' is set to OFF.

6-3-4 Re-calibrate All Devices

Activates the Discovery™ rapid drift compensation on all Discovery™ devices connected to the system.

This should be used after detectors have been serviced.

NOTE:

When this is activated it is necessary to write individually to every Discovery™ device connected to the system. This can take 60 seconds. During this time do not select any Discovery™ Specific programming functions (6-3-X).

ADVANCED
FUNCTIONALITY6-3-5 Check for Devices Needing Service

When activated this function reads the drift compensation value of every Discovery™ device connected to the system.

Any devices that are close to their drift compensation limit (and therefore will shortly be in need of servicing) are reported via the normal fault reporting mechanism. These 'FAULTS' will have the message 'DEVICE NEEDS SERVICE'. They can be reviewed once programming mode has been exited. Because they are reported as 'FAULTS' they are recorded in the event log and can therefore be reviewed and printed out using programming functions 1-1 and 1-2.

'Check for Devices Needing Service' reports 'DEVICE NEEDS SERVICE' when the device drift compensation is less than 6 or greater than 28. (The device itself will set it's drift flag at compensation values of 3 and 31 which will result in the system reporting a 'DRIFT WARNING' fault for the device.)

NOTE:

When this function is activated it is necessary to read from every Discovery™ device connected to the system. This can take 60 seconds. During this time do not select any Discovery™ Specific programming functions (6-3-X).

6-3-6 Read Data Stored in Device

Allows any of the data bytes stored in any Discovery™ device connected to the system to be read.

The byte read is displayed in decimal.

Reads will only be attempted on sub-panels that are set for Discovery™ detectors.

If the chosen device is not a Discovery™ device an error will be reported (this error is not logged).

6-3-7 Write Data Stored in Device

Allows a decimal value to be written to any of the four 8-bit user data locations in any Discovery™ device connected to the system starting at address 11. The values that can be inserted must lie within the range 0-255, otherwise it will cause an overflow of the byte value.

Writes will only be attempted on sub-panels that are set for Discovery™ detectors.

If the chosen device is not a Discovery™ device an error will be reported (this error is not logged).

One sample application for this capability would be to record in each Discovery™ compatible device the installation date (month/year). Using one byte for the month and another for the year. Another one would be to insert a code or reference for the installation.

ADVANCED FUNCTIONALITY

6-4 Automatic Address Setting (ASET) - [Wizmart Protocol only](#)

Introduction

Automatic Address Setting (ASET) is a special install and commissioning mode that can be activated on a per loop basis whilst in INSTALLATION mode. ASET mode is only required if Soft Addressable Modules (SAM's) are used in the fire protection system. Soft Addressable Modules (SAM's) do not have their addresses set using switches. They automatically assign their own addresses and ASET mode is used to achieve this.

Because ASET mode requires manual triggering of each device (using the standard test procedure for each one) the installer can effectively choose the address for each detector and simultaneously program and test each device.

SAM'S CAN BE MIXED WITH OTHER TYPES OF DEVICES ON THE SAME LOOP. Each time a SAM is programmed it takes the next free address on its loop.

General Guidelines

SAM's can only be used in conjunction with the following Wizmart Protocol panels:

- a) Juno Net
- b) Junior
- c) Sub panel (incorporating SIMM module & socket).

NOTE:

- [Verify panel software version by looking at number on the sticker placed on the SIMM card.](#)
- [SAM's cannot operate or be programmed when installed within loops associated with old Sub-Panel versions \(i.e. that do not include a SIMM card and socket\)](#)

Before starting the programming procedure, care should be taken with the following:

- a) Supply OK.
- b) Auxiliary Supply (Batteries) OK.
- c) Loop Supply OK.
- d) Verify the non-existence of earth current leakage.
- e) Verify the cable lengths for the loop.
- f) Confirm the non-existence of short or open circuits within the loop.
- g) Verify communications with standard analogue addressable devices is OK.
- h) Verify communications between Panel, and Repeaters with integrated Sub-Panel.

Verify that all SAM connections, both to the loop and the associated conventional device (i.e. smoke sensor/ detector, call point, etc.) are properly made and that the conventional device connections follow the manufacturer's instructions, in particular those regarding polarity. Reversal of the supply polarity can cause failure or malfunction and prevent a SAM from being programmed.

CAUTION

[Verify that there are no faults or fire conditions in the loop or system.](#)
[Clear all fault and fire conditions first.](#)

Reset to normal operation all devices before applying power to the panel, in particular manual call points

ADVANCED
FUNCTIONALITY

In order to initiate the programming procedure of the SAM's the Panel has to be in INSTALLATION MODE. See function 8.4.1.

6-4-1 Activate ASET Mode (SAM)

The enabling of this mode is done on a per loop basis. When the loop is in ASET MODE the TEST LED on the Panel, will be illuminated.

CAUTION

A loop while in ASET mode will not offer any kind of protection against fire conditions.

DO NOT remove or replace SAM's while loop is powered. If one of these modules has to be replaced or removed, first disconnect all supply sources to the panel.

CAUTION

Removal of a SAM while loop is powered can corrupt programming of this module and all other SAM's present in the loop.

Start SAM programming

Activate a blank SAM by either testing the device associated with it, either using the standard test procedure for the device or by short-circuiting both SAM device wires (i.e. BLACK & RED) simulating in this case a device activation. Smoke and heat detectors will have their alarm led permanently lit when activated. Sounders can be set to activate for approximately 1 second, using function 7.3, every time a new SAM is activated (i.e. fire condition). Upon activation of the conventional device and after a short delay (aprox. 3 seconds), the associated SAM is programmed with the next available address. During this delay the panel will execute a verification, where the new address and device will be confirmed and validated.

The programming of a new address can be monitored in four different ways, namely:

- a) Using function 7.1, after a new SAM has been programmed the device count will increase by one and by selecting the newly programmed address, the device type, address and analogue value can also be confirmed.
- b) Using function 7.3, the user can select to activate the sounders when a device enters the alarm state. When in ASET mode, the sounders will be activated for approximately one second, each time a device enters the fire condition and a new SAM address has been programmed. This will only affect loops where the ASET MODE was enabled after entering the SOUNDERS ON TEST ACTIVATION mode.
- c) Using function 1.1, the log of events can be used to verify the devices that have been programmed.

**ADVANCED
FUNCTIONALITY**

NOTE:

A programmed SAM that has been RESET and re-enters the fire condition will force the panel to activate the sounders without a new address being programmed. The panel will activate the bells/sounders every time there is a new fire condition, regardless of it being caused by a new address being attributed or not. Each new SAM programming should be confirmed and monitored in order to avoid misleading information originating from SAM's that have already been programmed.

This procedure is then repeated for each blank SAM on the loop. There should be a time interval of approx. 10 seconds between SAM activations.

After every 8th SAM activation the panel will reset the loop to clear the latched alarm conditions. When programming SAMs associated with CALL POINTS, the device should be manually reset, with the mechanical means provided by the manufacturer of the device, upon completion of the programming phase. In the case of smoke detectors, they will automatically reset after each loop reset if they are free from smoke. While the loop is in the reset state, no new SAM activations and therefore programming, should be taking place. This period has a duration of approximately 30 seconds.

NOTE:

- It two SAM's are simultaneously activated neither will be programmed with an address. One SAM must be activated (and programmed) at a time
- physically removing any device on a loop in ASET mode will free up the device address and the next SAM to be activated could potentially be assigned that address.

Two functions are provided to the installer, should the need arise to clear/ erase any or all SAM modules in a specific loop:

Function 6.4.2 Clear Loop

Use this function to clear/ erase all SAM's on the specified loop. Once erased, all SAM's on that loop must be reprogrammed using ASET mode. See function 6.4.1.

Function 6.4.3. Clear Device

Use this function to erase a single SAM on a specific loop.

NOTE:

- An erased/ blank SAM will not offer any fire protection.
- Both functions will operate even if the chosen loop is not in ASET mode.

After all SAM's have been programmed in a loop, perform a MASTER RESET to the panel followed by a confirmation, using function 7.1, that all devices have been correctly programmed (i.e. device address, type and analogue value).

SAM's will respond with the following fixed analogue values, depending on their state:

	NORMAL	FAULT	ACTIVATED-FIRE
Smoke	20	8	64
Heat	20	8	64
Call Point	20	N/A	64

UPON COMPLETION OF THE INSTALLATION AND COMMISSIONING STAGES A FIRE DETECTION SYSTEM SHOULD ALWAYS OPERATE IN ACTIVE MODE

TROUBLESHOOTING

a) SAM does not program

If during the course of programming a SAM, the new address is not programmed in the module, verify that the connections to both the loop and the conventional device are correctly made. Confirm supply polarity of the conventional device. Always follow manufacturer's instructions. Check loop voltage at the SAM terminals followed by a verification of the conventional device voltage, measure voltage across the supply wires (black & red). In normal operation it should always be greater than 16 V DC.

Verify the condition of the whole system in particular supplies (auxiliary and loop), earth leakage, loop length too long, loop with a short or open circuit, panel and sub-panel communications. If all of these are OK then do a system reset after which you should verify, using function 7.1, if there are devices with duplicated address. If there are, clear those addresses and reprogram SAM's that previously had identical addresses.

In the eventuality that one SAM does not program but there is no evidence of two devices having identical addresses after a system reset has been performed, clear the last programmed address using function 6.4.3 and reprogram SAM. If that does not solve problem replace SAM module. Remember that a duplicate address fault will only show with ASET mode disabled.

b) SAM with duplicate addresses

In an installation with SAM's, should there be a fault of 2 devices or more with the same address (duplicate address fault) two actions can be taken:

- 1) CLEAR LOOP. Clear the loop where some SAM's have duplicate addresses. See function 6.4.2. This action should only be applied when in a brand new installation where all SAM's should have been blank (no address programmed).
- 2) Alternatively the duplicated address can be erased using function 6.4.3

Reset the panel and verify, using function 7.1, the offending address and henceforth the associated FAULT condition has disappeared. Re-program cleared devices. Repeat procedure until fault disappears. If after the third time the address clearing procedure has been repeated the fault persists, replace those SAM's with have duplicate addresses.

It should be observed that this verification can only be performed when ASET mode is disabled, since the fault condition where 2 devices have the same address, is not shown when in this particular mode.

ADVANCED
FUNCTIONALITY

7 Monitor Device Counts & Test

7-1 Device Count, Type & Value

Use this function to check that all loop devices are present.

Use to select the device address on that loop.

This function is also useful to confirm the address of the various different types of devices connected to the Analogue Loop.

Note that in Installation Mode all information is live i.e. the count of devices will change as the panel learns and device types will be updated if they change. In Active Mode only the device value is live.

7-2 Test Sounders

Use this function to test the audibility of the sounders in a more comfortable manner than pressing SOUND ALARMS.

Panel

The Panel Conventional Sounders will sound for 1 second then be silenced for 9 seconds.

7-3 Sounders on Test Activation

This function allows you to choose an audible confirmation that a device has detected a fire. The audible confirmation consists of a 1 second period of sounder operation. The settings selected by this function are used by '7-4 Test Zones' and '6-4-1 Activate ASET Mode (SAM)'.

ALL SOUNDERS ON DETECTOR TEST activates the Panel Conventional and Loop Sounders.

NOTE:

Using this function AFTER '7-4 Test Zones' and '6-4-1 Activate ASET Mode (SAM)' will NOT change the settings for the zones already in test mode and the loops already in ASET mode.

7-4 Test Zones

Select the Zones you wish to put into test mode.

Exit programming mode, but DO NOT press SYSTEM RESET as this clears all test modes.

In test mode when a detector is activated the LED on the detector will be illuminated and the event will be reported on the Panel (and Repeaters) for 15 seconds. If selected then the sounders will also operate for 1 second. The LED on the detector is not latched and will clear when the alarm level falls below the alarm threshold for the device.

Pressing TEST QUEUE REVIEW will report the zones that are in Test Mode.

7-6 Light LED on device

This function can be used to confirm the physical location of a specific detector.

Select the device and SWITCHED ON and press ENTER. The device will typically take a few seconds to respond.

LEDs stay "ON" until reset is pressed.

Output device relay will change state if "LED on" is selected.

8 General

8-1 Time/Date & Timers

8-1-1 Set Date & Time

Allows the date and time for the system to be set. The date and time is displayed on the LCD whilst the system is not in fault or fire.

Press ENTER to skip an entry and after each entry.

It is important to set the date and time because it is used in the event logging and may also be used to change the detector sensitivities or to disable delays at night.

There is only one clock in the system. Setting the date and time at a Repeater is actually setting the Panel clock.

8-1-2 Define Day & Night

Defines sunrise and sunset for the system.

The system considers a day to start at sunrise. So when different detector sensitivities are set for different days (function 6-1-8) the new day will start at the sunrise time defined here.

If different sensitivities have been set for day and night (function 6-1-9) then the times defined here are the times the sensitivity change will take place.

If delays have been set to be switched off at night (function 8-1-3) then this will happen at the sunset time defined here.

8-1-3 Delays Off at Night

This function allows the delays for Sounders and I/O activation to be overridden at night.

There are two options: OFF and UNAFFECTED.

UNAFFECTED means that the system settings will remain the same at night as they are during the day.

OFF means that at night time the Sounder, I/O module and Fire Brigade Transmission delays are all turned off and the outputs will activate immediately a fire is detected.

This function has exactly the same effect as using the ACTIVE DELAYS button on the front panel to disable the delays at sunset, then using the same button to restore the day setting at sunrise.

Sunrise and sunset are defined using function 8-1-2.

ADVANCED
FUNCTIONALITY8-1-4 Configure Evacuate Timer

Allows the evacuate timer to be enabled and the duration of the timer to be set.

The evacuate timer runs in parallel to all other events. Once triggered it starts counting down, when it expires all sounders are activated. This means various sounder groups may be activated in the meantime (and even silenced) but when the evacuate timer expires all sounders not sounding are activated.

10 minutes is the maximum duration.

The Evacuate Timer can be set to:

DISABLED
DEVICE MODE
GLOBAL MODE

In DEVICE MODE the evacuate timer is started when a device that has been configured to start the Evacuate Timer detects a fire.

In GLOBAL MODE the Evacuate Timer is started when any device detects a fire.

NOTE:

- For DEVICE MODE to work at least one device must be set to start the timer. See programming function 8-1-5.
- Once started the evacuate timer is not stopped by pressing ALARM SILENCE, although ALARM SILENCE will still silence the sounders once they have been activated.
- Disabled sounders are never activated by the evacuate timer.

8-1-5 Device Starts Evacuate Timer

Allows you to specify specific detectors that will start the Evacuate Timer.

The Evacuate Timer must be in DEVICE MODE to be activated by specific devices. See programming function 8-1-4.

ADVANCED
FUNCTIONALITY

8-2 Special Features Set-up

Programming functions associated with the system response and detection of a fire.

8-2-1 Two Devices to Evacuate

Enables or disables a system wide setting that detection of fire by two detectors automatically starts evacuation.

Evacuation means any Sounder Group settings will be ignored and all sounders will be operated immediately.

NOTE:

Disabled sounders will not be activated.

8-2-2 Call Points to Evacuate

Enables or disables a system wide setting that a report of fire from a call-point automatically starts evacuation.

Evacuation means any Sounder Group settings will be ignored and all sounders will be operated immediately.

NOTE:

Disabled sounders will not be activated.

8-3 Memory - BEWARE, ENGINEERS ONLY

Programming functions that are associated with management of the Panel memory.

8-3-1 Clear Customer Flash Memory

This function erases all of the site specific data from the customer Flash memory on the SIM CARD. This is the majority of the programmed settings.

DO NOT erase this data if you were supplied with pre-programmed site data.

It is not recommended that this function is carried out from a Repeater as the erase will take a few seconds and during that time communication to the Repeater will be lost.

If the Customer Flash Memory is cleared:

- All Sounder Groups will have continuous sounder operation
- All Sounder Group definitions will be cleared
- The Sounder Configuration will be set to PRESET
- All Zone text will be cleared
- All Zone Sounder and I/O group settings will be cleared
- All Zone definitions will be cleared (no devices assigned)
- Zone sounder delay settings will be cleared
- The company name will be cleared
- All device text will be cleared
- All device specific settings will be cleared
- All sensitivity settings will be reset
- All delay settings will be cleared
- The language will be reset to English
- All I/O group definitions will be cleared
- User access to all programming functions will be denied

NOTE:

The Installer Access Code will not be cleared. After clearing the Customer Flash Memory it is essential to perform a system Master Reset to ensure the new settings are sent to all. (Settings are otherwise only sent when they are changed using the programming functions.)

8-3-2 Clear Non-Volatile RAM

Clearing the NVRAM clears all the installation settings and the system is automatically put into Installation Mode.

On the Panel this will result in:

- The Analogue Loop will be enabled
- All disabled Zones will be enabled
- All disabled devices will be enabled
- All disabled sounders will be enabled
- The event log will be cleared
- The auto-reset count will be cleared
- Information on fitted devices and their types will be cleared
- All checksums will be cleared and recalculated

After clearing the NVRAM it is essential to perform a system Master Reset.

8-3-3 Calculate Customer Flash Checksum

Calculates and stores the checksum for all the data in the customer Flash memory.

When settings are changed using the programming functions this checksum will be re-calculated as required. Downloads of customer data also result in an automatic update of the checksum. However if a SIM CARD is supplied with pre-programmed data (i.e the data changed externally) this function is necessary otherwise the panel will believe the data has been corrupted and report a fault.

This stored checksum is regularly (approximately every 2 minutes) compared with a freshly calculated checksum to check for memory corruption.

8-3-4 Calculate Program Flash Checksum

Unlikely to be required in normal circumstances, this function calculates and stores a checksum for the program Flash memory.

Software upgrades, either downloaded, or from a new SIM CARD are detected by the Panel and automatically result in a new checksum being calculated and stored.

This stored checksum is regularly (approximately every minute) compared with a freshly calculated checksum to check for memory corruption.

ADVANCED
FUNCTIONALITY

8-4 Other Features

These are programming functions that do not fall into any other category.

8-4-1 Active/Installation Mode

An essential function. The system should always be left in ACTIVE mode, unless the system is being installed and debugged.

When the system is set to Installation Mode the green SYSTEM ON LED on the front panel of the Panel and Repeaters will flash.

Whilst in Installation Mode the system will automatically detect and record the presence of all connected devices.

To install the system first ensure all detectors, sounders and are connected and have power. Next select Installation Mode using this function, exit programming mode and press SYSTEM RESET.

Once the system has been in Installation Mode for 90 seconds then the system can be put into Active Mode.

Note that there is no clear end to Installation mode because the system is constantly looking and learning. However if the system is put into Active Mode and Installation Mode hasn't had time to identify all system components you will very quickly be greeted with error reports regarding the presence of unexpected devices.

If devices are ever removed, replaced or added then Installation Mode must be selected so that the system can learn the new configuration. If you do not do this the system will report a fault.

8-4-2 Upload/Download Link to PC

Entering this function will automatically stop all normal fire alarm system operations including communications to Repeaters.

- It allows customer site data to be downloaded into the Customer Flash Memory.
- It allows customer site data to be uploaded from the Panel to a PC. You may wish to do this to save the configuration or for ease of editing. Once edited the data must be downloaded back into the panel.

To perform an upload or download you will need a lead for connection to a PC and the correct PC software.

Connection to a PC requires a pin-pin 9 way lead with a male D connectors at one end and a female D connector at the other end. (Only three wires are actually necessary, so if problems are encountered it is worth trying a lead with only three wires - Tx (pin 2), Rx (pin 3) and GND (pin5)).

Uploading/Downloading Customer Site Data

Depending on the amount of data transferred an Upload or Download can take up to 20 minutes.

It is not necessary to enter Installation Mode after uploading or downloading Customer data. But a Panel Master Reset is essential (and will happen automatically when the Panel is powered up).

ADVANCED FUNCTIONALITY

The PC Loader Software

The PC Loader software is runs under Windows® (98, 98SE, Me, 2000 and XP). Communications to the panel is through one of the serial communication ports (COMM PORT) and in order to install it, the only requirement is to double click on the installer package supplied and follow the supplied instructions.

Windows® COMM PORT Set-up

Please consult our other document entitled "GFE CONNECTOR SOFTWARE" for more detailed instructions.

The Panel

Before connecting the extension RS232 lead, disconnect the power to the panel.

Connect the RS232 lead to the panel socket, reapply power to the panel, return to programming mode and go to function 8-4-2 do NOT press Enter yet. Connect other end of RS232 cable to PC serial port, now press Enter on the panel.

Once you have entered the loader program in the PC and selected upload/download, press the ENTER key in the panel to start the process, and then start the upload/download on the PC.

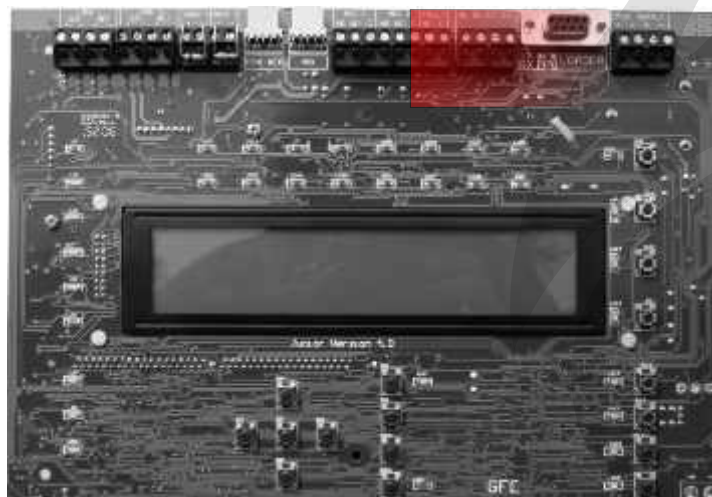
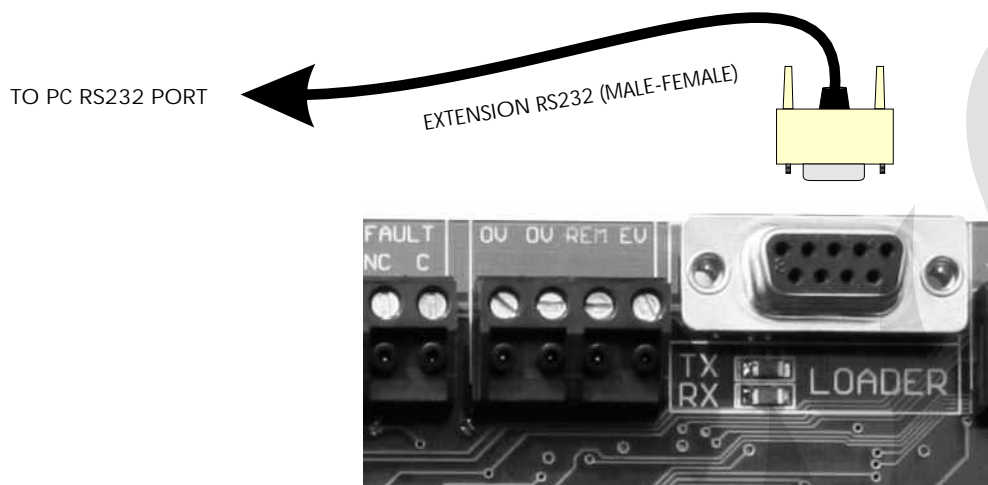

ADVANCED
FUNCTIONALITY

8-4-4 Set User Access Code

This function allows the installer to change the customer Access Code. Use to change code sequence.

8-4-5 Set User Functions

Allows the user access level to be set for every programming function.

Settings are: NONE - READ ONLY - FULL ACCESS

Do not set 8-4-5 Set User Functions to FULL ACCESS or the user will be able to enable all the other functions!

It is not appropriate to set some functions to READ ONLY - for example "8-3-4 Calculate Program Flash Checksum".

The default setting for all programming functions is NONE.

8-4-6 Select language

Allows the language setting to for the system to be set.

Do this carefully - you will need to navigate back to this function to change it back again.

All text in the system will be changed to use the selected language. The change will take effect when ENTER is pressed.

Languages supported are:

BRAZILIAN - ENGLISH - HUNGARIAN - ICELANDIC - ITALIAN - PORTUGUESE - SPANISH

8-4-8 Set Installer Access Code

This function allows changing the Installer Code without requiring knowledge of the Factory Code.

Display will show:

ENTER PRESENT CODE
ENTER NEW CODE
CONFIRM NEW CODE

**TECHNICAL
SPECIFICATIONS**

Please note that these specifications apply to the Junior Analogue Addressable panel, 1 or 2 loop models, equipped with a 2.4 Amp power supply @ 28.5V DC nominal.

Weight:	Empty: 1.6 Kg Including sealed lead acid batteries: 2 x 12 V 7 AH 7.0 Kg
Operating temperature:	-5°C to + 40°C
Relative Humidity:	85% (non-condensing)
Conventional Sounder Circuits:	2 individually programmed. Both circuits current limited and monitored for both open and short circuit fault conditions. 10k Ohm E.O.L. resistors are used. Maximum current rating per circuit 400mA.
Auxiliary Relay Outputs:	2 voltage free changeover relay outputs used for fire indication. 1 voltage free relay output for fault indication. Remains energised (normally closed) under normal condition and de-energises when any fault condition appears on the system. Maximum current rating for each relay contact 1A @ 50 V AC/DC resistive.
Sensor / Loop Circuits:	1 loop model. Max. number of devices per loop: 125 Supports analogue addressable devices over a 2 wire combined power and digital data transmission loop. Maximum Loop current : 275mA Loop short circuit (trip) current: 900mA Maximum recommended loop length is 1 km with 1.5 mm ² wire cross-section. Maximum cable capacitance 120 pF/m. Minimum cable cross-section: 0.5 mm ² Maximum cable cross-section: 2.5 mm ²
<u>Power Supply and Charger</u>	
Primary Supply:	230V +10%/ -15% V AC.
Input Operating Voltage:	4 Amp - Surge protected (slow blow)
Mains electrical fuse:	20 mm HRC Fuse located on electrical mains connector TB, placed above the PSU inside the box.

WARNING: In case of a short circuit or interruption of the analogue detection loop, only a maximum of 32 detectors or call points (per loop) can be prevented, at any given time, of transmitting a fire alarm. In order to assure compliance with this clause, loop isolators have to be installed every 32 devices in the loop

TECHNICAL SPECIFICATIONS

Maximum Continuous Primary Power Supply Rating:

2.4 Amps @ 28,5 V DC nominal, comprising:

1 Amp max. temperature compensated, short circuit protected, battery charger.

1.4 Amp used for internal electronic circuits and external ancillary circuits: A maximum of 275 mA is available for loop power.

Maximum of 100 mA for internal electronic circuits.

460 mA for auxiliary power supply outputs.

Under alarm conditions a maximum of 1 Amp current available for conventional sounder circuits.

Power Budget Quiescent Condition:

- a - 100 mA internal circuits
- b - 460 mA auxiliary supply outputs
- c - 275 mA for analogue loop power
- d - 1 Amp for battery charger.

Alarm Condition:

800 mA for conventional sounder circuits + a + b + c

DC Output Voltage:

Maximum 28,5 V DC
Minimum 19,7 V DC

Max. Ripple Voltage:

400 mV peak-to-peak @ Maximum output loading.

Battery Charger Output:

27,5 V DC nominal @ 20°C

Secondary Supply:

24 V sealed lead acid batteries.
Maximum capacity 2 x 7 AH
Both fitted internally.
Min. Voltage 21,0 V DC (Vb min)
Max. Voltage 27,2 V DC
Max. Current Output 1.85 Amp

Battery Fuse 1.85 A - Resettable Electronic Fuse
Maximum Internal Resistance 1 Ohm

Mini-Repeater

Supply voltage
Quiescent current
Dimensions

24V DC nominal
90mA
W 340mm x H 370mm x D 125mm

DECLARATION OF CE CONFORMITY

GFE S.A., manufacturer of addressable fire detection equipment, declares, that the JUNIOR fire control panel and repeater panels conform to the following directives of the EEC commission:

Construction Products Directive 89/106/EEC amendment 93/68/EEC
Low Voltage directive and amendment 2006/95/EC
EMC Directive and amendments 2004/108/EC

and comply with the following standards:

EN55022 class B, EN61000-4-22,3,4,5,6,8,11
EN61000-3-2,3 EN54-2 and EN54-4.

We, Global Fire Equipment S.A. hereby declare, for the effects of the requirements laid down with EN54-4 paragraph 6.1, that the power supply equipment included in our analogue addressable fire alarm panel named JUNIOR, has been designed in accordance with a quality management system which incorporates a set of rules for the design of all elements of the p.s.e., and that its components have been selected for the intended purpose, and expected to operate within their specification when the environmental conditions outside the cabinet comply with class 3k5 EN60721-3-3:1995

We, Global Fire Equipment S.A. hereby declare, for the effects of the requirements laid down with EN54-2 paragraph 12.1, that the control and indicating equipment which is our analogue addressable fire alarm panel named JUNIOR, has been designed in accordance with a quality management system which incorporates a set of rules for the design of all elements of the c.i.e. and its components have been selected for the intended purpose, and are expected to operate within their specification when the environmental conditions outside its cabinet comply with class 3k5 EN60721-3-3:1995

We, Global Fire Equipment S.A. hereby declare, for the effects of the requirements laid down with EN-54 Pt4 paragraph 6.3.2, that the power supply equipment included in our analogue addressable fire alarm panel named JUNIOR, is in accordance with EN 60950-1:2006 with the A11:2009 and A1:2010 amendments for protections against direct and indirect contact, for the separation of the extra low voltage DC circuits from the low voltage AC circuits and for earthing of metal parts.



João Paulo Galvão
Managing Director

This panel is **CE** marked to show that it conforms to the requirements of the above European Community Directives:

It is assumed that the user of this manual is a suitably-trained operator/maintainer

WARNING

THIS PANEL CONTAINS (LIVE) VOLTAGE. ALWAYS DISCONNECT THE MAINS SUPPLY FROM THE PANEL BEFORE REMOVING OR INSTALLING COMPONENTS.



ELECTRO-STATIC SENSITIVE DEVICES (ESD) TAKE SUITABLE ESD PRECAUTION WHEN REMOVING OR INSTALLING PRINTED CIRCUIT BOARDS.

GLOBAL
FIRE EQUIPMENT

M.A.R.F, Sítio do Guelhim, Armazens F3 e F4, 8009-021 FARO, PORTUGAL

TEL.: +351 289 896 560 FAX.: +351 289 865 587 e-mail: sales@globalfire.pt website: www.globalfire.pt